



Photo courtesy Javed Karim via Pano

West Bay Sanitary District
Recycled Water Project - Sharon Heights
Mitigated Negative Declaration



WEST BAY
SANITARY DISTRICT



FINAL
November 24, 2015



West Bay Sanitary District
Recycled Water Project – Sharon Heights
Mitigated Negative Declaration
FINAL

Prepared for:
West Bay Sanitary District
500 Laurel Street
Menlo Park, CA 94025



In collaboration with:
Rincon Consulting, Inc.

Adopted
November 24, 2015

This page intentionally left blank

Environmental Determination	1-1
Chapter 1 Introduction	1-4
1.1 Project Background and Purpose	1-4
1.2 Scope and Use of this Document	1-4
1.2.1 Impact Terminology	1-6
1.2.2 Recommended Level of Environmental Documentation	1-6
Chapter 2 Project Description	2-1
2.1 Project Location	2-1
2.1.1 Background	2-1
2.1.2 Project Objectives.....	2-1
2.1.3 Water Demands	2-2
2.2 Proposed Project Components.....	2-3
2.2.1 Pipelines	2-4
2.2.2 Wastewater Treatment.....	2-6
2.2.3 Pump Stations.....	2-8
2.3 Operation and Maintenance Requirements	2-9
2.3.1 Pipelines	2-9
2.3.2 Wastewater Treatment Plant	2-10
2.3.3 Pump Stations.....	2-11
2.4 Construction Considerations	2-11
2.4.1 Pipeline Construction	2-11
2.4.2 WWTP Construction	2-13
2.4.3 Pump Station Construction.....	2-14
2.4.4 Planned Traffic Controls	2-15
2.5 Responsible Agencies, Permits and Approvals.....	2-15
Chapter 3 Environmental Checklist	3-1
3.1 Aesthetics	3-1
3.2 Agriculture and Forestry Resources	3-3
3.3 Air Quality.....	3-4
3.4 Biological Resources.....	3-9
3.5 Cultural Resources	3-15
3.6 Geology and Soils	3-18
3.7 Greenhouse Gas Emissions	3-22
3.8 Hazards and Hazardous Materials.....	3-23
3.9 Hydrology and Water Quality	3-26
3.10 Land Use and Planning.....	3-31
3.11 Mineral Resources.....	3-32
3.12 Noise.....	3-33
3.13 Population and Housing	3-36
3.14 Public Services	3-37
3.15 Recreation.....	3-38
3.16 Transportation/Traffic	3-38
3.17 Utilities and Service Systems	3-40
3.18 Mandatory Findings of Significance	3-42

Chapter 4 Federal Cross-cutting Environmental Regulations Evaluation	4-1
4.1 Federal Endangered Species Act	4-1
4.2 National Historic Preservation Act (NHPA), Section 106	4-1
4.3 Clean Air Act.....	4-1
4.4 Coastal Zone Management Act	4-2
4.5 Farmland Protection Policy Act	4-2
4.6 Executive Order (EO) 11988 – Floodplain Management	4-2
4.7 Federal Migratory Bird Treaty Act, Bald and Golden Eagle Protection Act, and Executive Order 13168	4-2
4.8 Executive Order 11990 – Protection of Wetlands.....	4-3
4.9 Wild and Scenic Rivers Act	4-3
4.10 Safe Drinking Water Act – Source Water Protection.....	4-3
4.11 Executive Order on Trails for America in the 21 st Century	4-3
4.12 Executive Order 13007 – Indian Sacred Sites.....	4-3
4.13 Magnuson-Stevens Fishery Conservation and Management Act.....	4-3
4.14 Environmental Justice	4-4
Chapter 5 Report Preparation	5-1
5.1 Report Authors	5-1
5.2 References	5-1
Table 2.1-1: Recycled Water Demands	2-3
Table 2.2-1: Pump Station Summary.....	2-9
Table 2.2-1: Recycled Water Pipeline General Maintenance Schedule	2-10
Table 3.3-1: Proposed Project Maximum Daily Construction and Operational Emissions	3-6
Table 3.3-2: Proposed Project Annual Construction and Operational Emissions	3-7
Table 3.9-1: Guidelines for Interpretation of Water Quality for Irrigation	3-29
Table 3.9-2: Landscape Irrigation Water Quality Comparison	3-30
Table 3.12-1: General Plan Noise Limits for Residential Areas in the City of Menlo Park	3-35
Table 4.13-1: EJSCREEN Census 2010 Summary Report Information.....	4-4
Figure 2.1-1: Project Location	2-2
Figure 2.2-1: Sharon Heights Satellite Facility Project Process Flow Schematic	2-3
Figure 2.2-2: Proposed Pipeline Alignments.....	2-5
Figure 2.2-3: Treatment Facilities.....	2-7
Figure 2.2-4: Wastewater Pump Station Facilities	2-8
Figure 3.2-1: Farmland Mapping and Monitoring Program (FMMP) Land Designation Map ...	3-4
3-4	
Figure 3.6-1. Active Fault Systems with potential to affect Study Area	3-19
Figure 3.6-2. Shaking Hazard Map of the Study Area (Estimated MMI within the Region, due to an Active Fault Line Rupturing).....	3-20
Figure 3.6-3. Liquefaction Risk within Study Area.....	3-21
Figure 4.13-1: Low Income Communities in Study Area	4-5

Appendices

Appendix A - Recycled Water Facilities Plan

Appendix B - General Conformity Report and Air Quality Analysis

Appendix C - Biological Resources Assessment

Appendix D - Cultural Resources Assessment

Appendix E - Hazardous Sites Mapping

Acronym List

ABAG	Association of Bay Area Governments
AFY	Acre-feet per year
APE	Area of potential effect
BAAQMD	Bay Area Air Quality Management District
BMPs	Best Management Practices
BRA	Biological Resource Assessment
CAA	Clean Air Act
CBC	California Building Code
CCR	California Code of Regulations
CCTV	Closed circuit television
CESA	California Endangered Species Act
CEQA	California Environmental Quality Act
CFGC	California Fish & Game Code
CHRIS	California Historical Resources Information System
CNDDDB	California Natural Diversity Database
CNPS	California Native Plant Society
CRHR	California Register of Historical Resources
CRLF	California red-legged frog
CRZ	Critical root zone
CTS	California tiger salamander
CWA	Clean Water Act
CY	Cubic Yards
CZMA	Coastal Zone Management Act
DAC	Disadvantaged Community
DDW	Division of Drinking Water
DTSC	(California) Department of Toxic Substances Control
DWR	Department of Water Resources
EO	Executive Order
FEMA	Federal Emergency Management Agency
FESA	Federal Endangered Species Act
FHSZ	Fire Hazard Severity Zone
FIRM	Flood Insurance Rate Map
FMMP	Farmland Mapping and Monitoring Program
FPPA	Farmland Protection Policy Act
GHG	Greenhouse gas
gpm	Gallons per minute

HCP	Habitat Conservation Plan
HDD	Horizontal directional drill
hp	Horsepower
IBC	International Building Code
IS/MND	Initial Study/Mitigated Negative Declaration
LF	Linear feet
LID	Low impact development
LTS	Less than significant impact
LTSM	Less than significant impact with mitigation incorporation
LUST	Leaking underground storage tank
MBR	Membrane bioreactor
MBTA	Migratory Bird Treaty Act
MF	Microfiltration
mgd	Mega gallons per day
mld	Most likely descendant
mm	Millimeter
MMI	Modified Mercalli Intensity
MND	Mitigated Negative Declaration
MOU	Memorandum of Understanding
MPMWD	Menlo Park Municipal Water District
MRZ	Mineral Resource Zone
MS4	Municipal Separate Storm Sewer System
NAHC	Native American Heritage Commission
NEPA	National Environmental Policy Act
NHPA	National Historic Preservation Act
NI	No impact
NIC	Northwest Information Center at Sonoma State University
NOAA	National Oceanic and Atmospheric Administration
NPDES	National Pollutant Discharge Elimination System
NRHP	National Register of Historic Places
O&M	Operations and maintenance
OSC	Open Space and Conservation District
OSHA	(California) Occupational Safety and Health Administration
PG&E	Pacific Gas & Electric Company
PM	Particulate Matter
PMP	Paleontological Mitigation Plan
PSI	Potential Significant Impact

RWQCB	Regional Water Quality Control Board
RMC	RMC Water and Environment
ROW	Right-of-way
SFGS	San Francisco garter snake
SFPUC	San Francisco Public Utilities Commission
SHG&CC	Sharon Heights Golf & Country Club
SHPO	State Historic Preservation Officer
SLAC	SLAC National Accelerator Laboratory
SMARA	Surface Mining and Reclamation Act
SVCW	Silicon Valley Clean Water
SWPPP	Storm Water Pollution Prevention Plan
SWRCB	State Water Resources Control Board
TPZ	Tree protection zone
UBC	Uniform Building Code
UF	Ultrafiltration
USDA	US Department of Agriculture
USEPA	US Environmental Protection Agency
USFWS	US Fish and Wildlife Service
USGS	US Geological Survey
UV	Ultraviolet
UWMP	Urban Water Management Plan
WBSD	West Bay Sanitary District
WDR	Waste discharge requirements
WPT	Western pond turtle
WWTP	Wastewater treatment plant

Environmental Determination

- 1. Project Title:** West Bay Sanitary District Recycled Water Project - Sharon Heights
- 2. Lead Agency Name and Address:** West Bay Sanitary District
- 3. Contact Person and Phone Number:** Phil Scott, District Manager
West Bay Sanitary District
500 Laurel Street
Menlo Park, CA 94025
(650) 321-0384
- 4. Project Location:** City of Menlo Park
- 5. Project Sponsor's Name:** West Bay Sanitary District
- 6. General Plan Designation:**
 - The treatment facility would be constructed in an area designated as open space.
 - The pipelines would be constructed in roadway ROWs within medium/low density residential, public/institutional, and business park designated areas.
- 7. Zoning:¹**
 - The treatment facility would be constructed in an area located in the OSC² zoning district.
 - The pipelines would be constructed in roadway ROWs in areas zoned OSC, C1C³, R1S⁴, R3A⁵, C1⁶, and C2⁷ zoning districts.
- 8. Description of Project:** The Proposed Project would consist of a satellite wastewater treatment plant (WWTP) on the Sharon Heights Golf & Country Club (SHG&CC) property, an influent supply pipeline under Sand Hill Road, a pump station for the influent supply, recycled water distribution pipeline to SLAC and the golf course irrigation system, and a solids discharge pipeline to the existing sewer system. The Proposed Project would allow the West Bay Sanitary District (WBSD) to treat water for

¹ As a sanitary district organized and existing under the Sanitary District Act of 1923 (Cal. Health & Safety Code §6500, et seq.), WBSD has independent authority to “acquire, plan, construct, reconstruct, alter, enlarge, law, renew, replace, maintain, and operate ... water recycling and distributions systems” within its jurisdictional boundaries.

² Zoning Code Designation—Open Space and Conservation District; General Plan Land Use Designation—Parks and Recreation.

³ Zoning Code Designation—Administrative, Professional and Research District, Restrictive; General Plan Land Use Designation—Professional and Administrative Offices.

⁴ Zoning Code Designation—Single Family Suburban Residential District; General Plan Land Use Designation—Low Density Residential.

⁵ Zoning Code Designation—Garden Apartment Residential District; General Plan Land Use Designation—Medium Density Residential.

⁶ Zoning Code Designation—Administrative and Professional District, Restrictive; General Plan Land Use Designation—Professional and Administrative Offices.

⁷ Zoning Code Designation—Neighborhood Shopping District Retail/Commercial

reuse within the service district to meet customer demands. Waste sludge and washwater produced by the treatment process would be conveyed via a new discharge pipeline to the existing sewer system.

9. **Surrounding Land Uses and Setting:** The WWTP would be located on the southwest side of the SHG&CC property, which is located in the OSC zoning district. The influent supply pipeline and discharge pipeline would be located in existing ROWs. Other surrounding land uses include residential and commercial uses along Sand Hill Road. A small, private school is also located along the alignment on Sand Hill Road. The discharge pipeline would be constructed in SHG&CC property, adjacent to commercial and residential land uses. A figure showing the project location is provided in Chapter 2.
10. **Other public agencies whose approval is required (e.g., permits, financing approval, or participation agreement).** Multiple federal, state, and local agencies as listed in Chapter 2.

Environmental Factors Potentially Affected

The proposed project could potentially affect (“Potentially Significant Impact” or “Less than Significant Impact with Mitigation Incorporated”) the environmental factor(s) checked below. The following pages present a more detailed checklist and discussion of each environmental factor and identifies where mitigation measures would be necessary to reduce all impacts to less than significant.

- | | | |
|--|---|--|
| <input checked="" type="checkbox"/> Aesthetics | <input type="checkbox"/> Agricultural and Forestry Resources | <input checked="" type="checkbox"/> Air Quality |
| <input checked="" type="checkbox"/> Biological Resources | <input checked="" type="checkbox"/> Cultural Resources | <input type="checkbox"/> Geology and Soils |
| <input type="checkbox"/> Greenhouse Gas Emissions | <input checked="" type="checkbox"/> Hazards/Hazardous Materials | <input type="checkbox"/> Hydrology and Water Quality |
| <input type="checkbox"/> Land Use and Planning | <input type="checkbox"/> Mineral Resources | <input checked="" type="checkbox"/> Noise |
| <input type="checkbox"/> Population and Housing | <input type="checkbox"/> Public Services | <input type="checkbox"/> Recreation |
| <input checked="" type="checkbox"/> Transportation/Traffic | <input type="checkbox"/> Utilities and Service Systems | <input checked="" type="checkbox"/> Mandatory Findings of Significance |

DETERMINATION: (To be completed by Lead Agency)

On the basis of this initial study:

- I find that the proposed project COULD NOT have a significant effect on the environment, and a NEGATIVE DECLARATION will be prepared.
- I find that although the proposed project could have a significant effect on the environment, there will not be a significant effect in this case because revisions in the project have been made by or agreed to by the project proponent. A MITIGATED NEGATIVE DECLARATION will be prepared.
- I find that the proposed project MAY have a significant effect on the environment, and an environmental impact report is required.
- I find that the proposed project MAY have a “potentially significant impact” or “potentially significant unless mitigated” impact on the environment, but at least one effect 1) has been adequately analyzed in an earlier document pursuant to applicable legal standards, and 2) has been addressed by mitigation measures based on the earlier analysis as described on attached sheets. An ENVIRONMENTAL IMPACT REPORT is required, but it must analyze only the effects that remain to be addressed.

- I find that although the proposed project could have a significant effect on the environment, because all potentially significant effects (a) have been analyzed adequately in an earlier EIR or NEGATIVE DECLARATION pursuant to applicable standards, and (b) have been avoided or mitigated pursuant to that earlier EIR or NEGATIVE DECLARATION, including revisions or mitigation measures that are imposed upon the proposed project, no further environmental documentation is required.

November 24, 2015

Signature

Date

Phil Scott, District Manager

West Bay Sanitary District

Printed Name

For

Chapter 1 Introduction

This document is a Mitigated Negative Declaration (MND) that addresses the potential environmental impacts of construction and operation of the West Bay Sanitary District (WBSD or District) Recycled Water Project. This MND has been prepared by WBSD as lead agency under the California Environmental Quality Act (CEQA).

1.1 Project Background and Purpose

WBSD maintains and operates over 200 miles of main line sewer in the City of Menlo Park and portions of the cities of East Palo Alto and Redwood City, the towns of Atherton, Woodside and Portola Valley, and portions of unincorporated San Mateo and Santa Clara Counties. The raw wastewater collected by WBSD is conveyed to Silicon Valley Clean Water (SVCW), located in Redwood City, where the wastewater is treated and discharged or reused.

WBSD proposes a two-phased approach to construct a satellite wastewater treatment plant (WWTP), an influent pump station and pipeline, a solids discharge pipeline back to the sewer, and a recycled water pump station and delivery pipelines within the Sharon Heights Golf & Country Club (SHG&CC) and along existing roadway rights-of-way (ROWs). The WWTP, influent pump station and pipeline, solids discharge pipeline, and recycled water distribution to serve the SLAC National Accelerator Laboratory (SLAC) would be constructed in Phase I. Phase II would consist of additional recycled water pipelines to serve additional customers in the vicinity of SHG&CC. The Study Area for this Proposed Project is defined as an estimated 2.5-square-mile area in western Menlo Park, including SHG&CC and roadways along the pipeline alignments. Project facilities are shown in Figure 1.1-1.

The WWTP would be operated year-round and include grit removal, fine screening, a membrane bioreactor (MBR) treatment system, UV disinfection, effluent pump station, recycled water distribution pipeline, electrical substation, waste disposal pipeline, and associated equipment and appurtenances to support the treatment facility. The influent pipeline would transport wastewater to the WWTP from an existing sewer line. The disposal pipeline would transport waste and wash from the WWTP to the WBSD sewer system. The Phase I recycled water pipelines would transport tertiary treated recycled water to SLAC, as well as a separate tie-in to an existing irrigation pipeline to a nearby existing 2 million gallon open reservoir, located at the western edge of the Sharon Heights property. The Phase II recycled water pipelines would transport tertiary treated recycled water to customers in the vicinity of SHG&CC. The pipelines would primarily be constructed within Sharon Heights property and the roadway ROWs. A detailed Project Description, including more detailed figures and a list of potential permits and approval requirements, is provided in Chapter 2.

1.2 Scope and Use of this Document

This MND provides an assessment of the potential impacts to environmental resources that would result from implementing the Proposed Project. The discussion and level of analysis are commensurate with the expected magnitude and severity of each impact to environmental resources. This document primarily addresses the environmental effects of constructing and operating recycled water infrastructure and the effects of using the water supplies under consideration.

Figure 1.1-1: Proposed Recycled Water Project Facilities

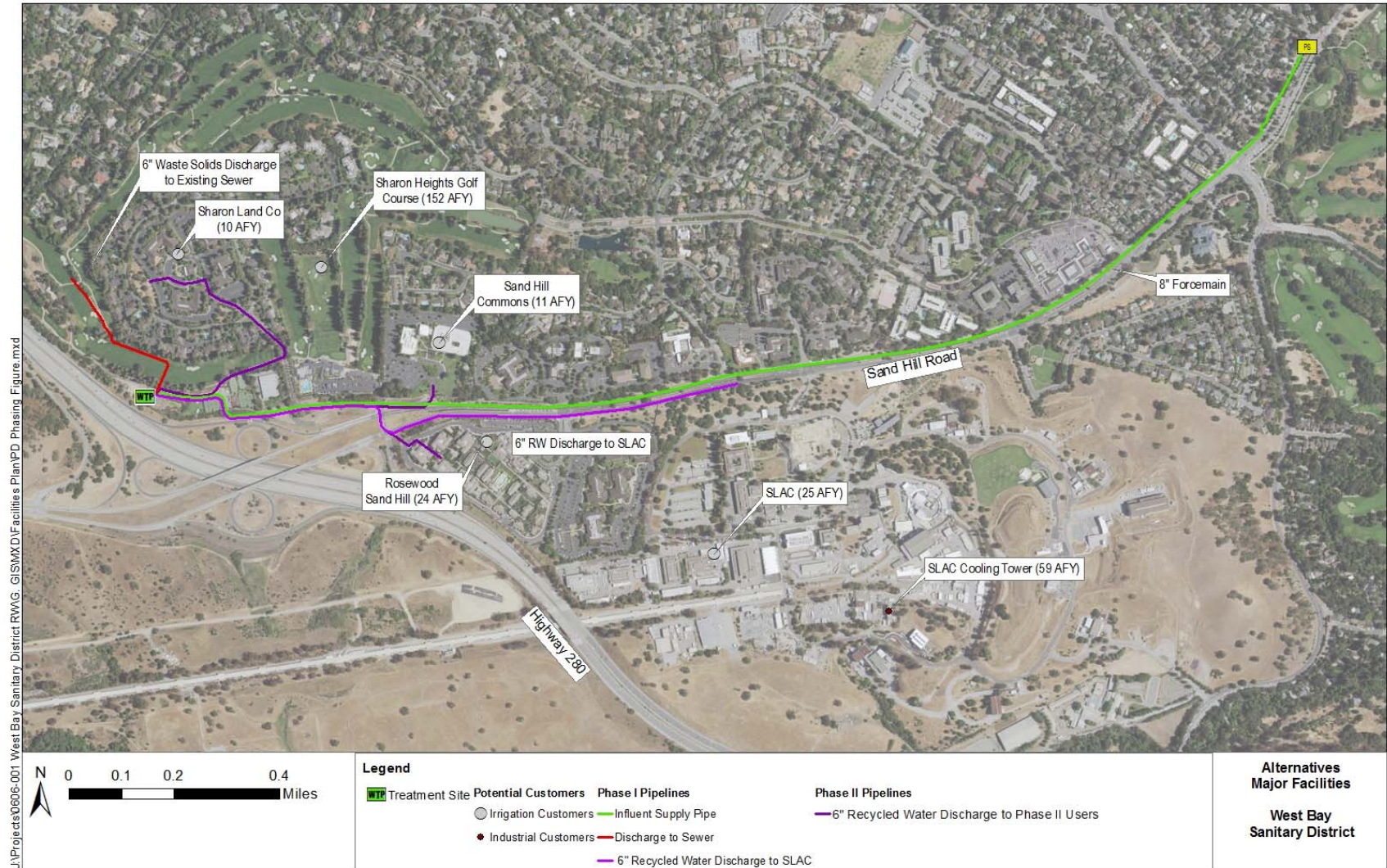

This document evaluates the potential for impacts to resources areas identified in Appendix G of the CEQA Guidelines. These resources areas include:

- Aesthetics
- Agriculture and Forestry Resources
- Air Quality
- Biological Resources
- Cultural Resources
- Geology and Soils
- Greenhouse Gas Emissions
- Hazards and Hazardous Materials
- Hydrology and Water Quality
- Land Use and Planning
- Mineral Resources
- Noise
- Population and Housing
- Public Services
- Recreation
- Transportation and Traffic
- Utilities and Service Systems
- Mandatory Findings of Significance

1.2.1 Impact Terminology

The anticipated environmental impacts are identified for each of the resource areas listed above. The level of significance for each resource area uses CEQA terminology as specified below:

- **No Impact (NI):** Checked if brief statements (one or two sentences) or cited reference materials (maps, reports or studies) clearly show that the type of impact could not be reasonably expected to occur due to the specific characteristics of the project or its location (e.g. the project falls outside the nearest fault rupture zone and relevant citations are provided). The referenced sources may also show that the impact simply does not apply to projects like the one involved.
- **Less than Significant (LTS):** Checked if a more detailed discussion of existing conditions and specific project features, also citing relevant information, reports or studies, demonstrates that, while some effects may be discernible with regard to the individual environmental topic of the question, the effect would not exceed a CEQA threshold of significance. The discussion may note that due to the evidence that a given impact would not occur or would be less than significant, no mitigation measures are required.
- **Less than Significant Impact with Mitigation Incorporation (LTSM):** Checked if the discussion of existing conditions and specific project characteristics, also adequately supported with citations of relevant research or documents, determine that the project clearly would or is likely to have particular physical impacts that would exceed the given threshold or criteria by which significance is determined, but that with the incorporation of anticipated mitigation measures into the project, that the project applicant or proponent has agreed to, such impacts would be avoided or reduced to less than significant levels.
- **Potentially Significant Impact (PSI):** Checked if a discussion of the existing setting (including relevant regulations or policies pertaining to the subject) and project characteristics with regard to the environmental topic demonstrates, based on substantial evidence, supporting information, previously prepared and adopted environmental documents, and specific criteria or thresholds used to assess significance, that the project would have a potentially significant impact of the type described in the question.

1.2.2 Recommended Level of Environmental Documentation

Based on the analysis presented herein, an MND is the appropriate level of environmental documentation for the Proposed Project.

This page intentionally left blank

Chapter 2 Project Description

The Proposed Project consists of a satellite WWTP, wastewater supply pump station and conveyance pipeline, and recycled water pump station and discharge pipelines. This project description relies upon information from the *Recycled Water Market Survey* (RMC, 2014) and the *Recycled Water Facilities Plan* (RMC, 2015).

2.1 Project Location

The project is located in eastern San Mateo County in the City of Menlo Park (City) at the SHG&CC. The City is surrounded by the San Francisco Bay to the north and east, the cities of East Palo Alto, Palo Alto and Stanford to the south, and the cities of Atherton and Redwood City to the west, as shown on Figure 2.1-1.

WBSD maintains and operates over 200 miles of main line sewer in the City of Menlo Park and portions of the cities of East Palo Alto and Redwood City, the towns of Atherton, Woodside and Portola Valley, and portions of unincorporated San Mateo and Santa Clara Counties. Raw wastewater is collected by WBSD and conveyed to the SVCW wastewater treatment plant located in Redwood City, where it is treated and discharged or reused.

2.1.1 Background

SHG&CC is located at the southwestern boundary of the City of Menlo Park and is spread out over approximately 170 acres. The satellite treatment plant project site includes approximately half an acre of undeveloped, but previously disturbed, land near the southern boundary of the property near Highway 280 and will include the existing adjacent two million gallon unlined, open reservoir. Pipelines outside of the Sharon Heights property will be aligned in Sand Hill Road. The proposed pump station site is located in a cul-de-sac northeast of the project site at the intersection of Sand Hill Road and Oak Avenue.

2.1.2 Project Objectives

The objective of Phase I of the project is to supply up to 236 acre-feet per year (AFY) of recycled water (up to 152 AFY to SHG&CC and up to 84 AFY to SLAC). The recycled water produced by this project will provide SHG&CC and SLAC with new sources of irrigation and cooling tower water. The objective of Phase II of the project is to supply up to 44 AFY of recycled water to the two business parks and homeowner's association in the vicinity of the golf course. Phase II was evaluated for potential environmental impacts, however, this phase of the project is not recommended for implementation at this time.

Currently, the sole source of potable water has been the City and County of San Francisco's regional system, operated by the San Francisco Public Utilities Commission (SFPUC). The SFPUC system supply is predominantly snowmelt from the Sierra Nevada Mountains, delivered through the Hetch Hetchy aqueducts. The SFPUC wholesales water to the Menlo Park Municipal Water District (MPMWD) which is the water retailer for customers within the City. Phase I and Phase II of the proposed project would offset potable usage by approximately 236 AFY and 45 AFY, respectively.

Figure 2.1-1: Project Location

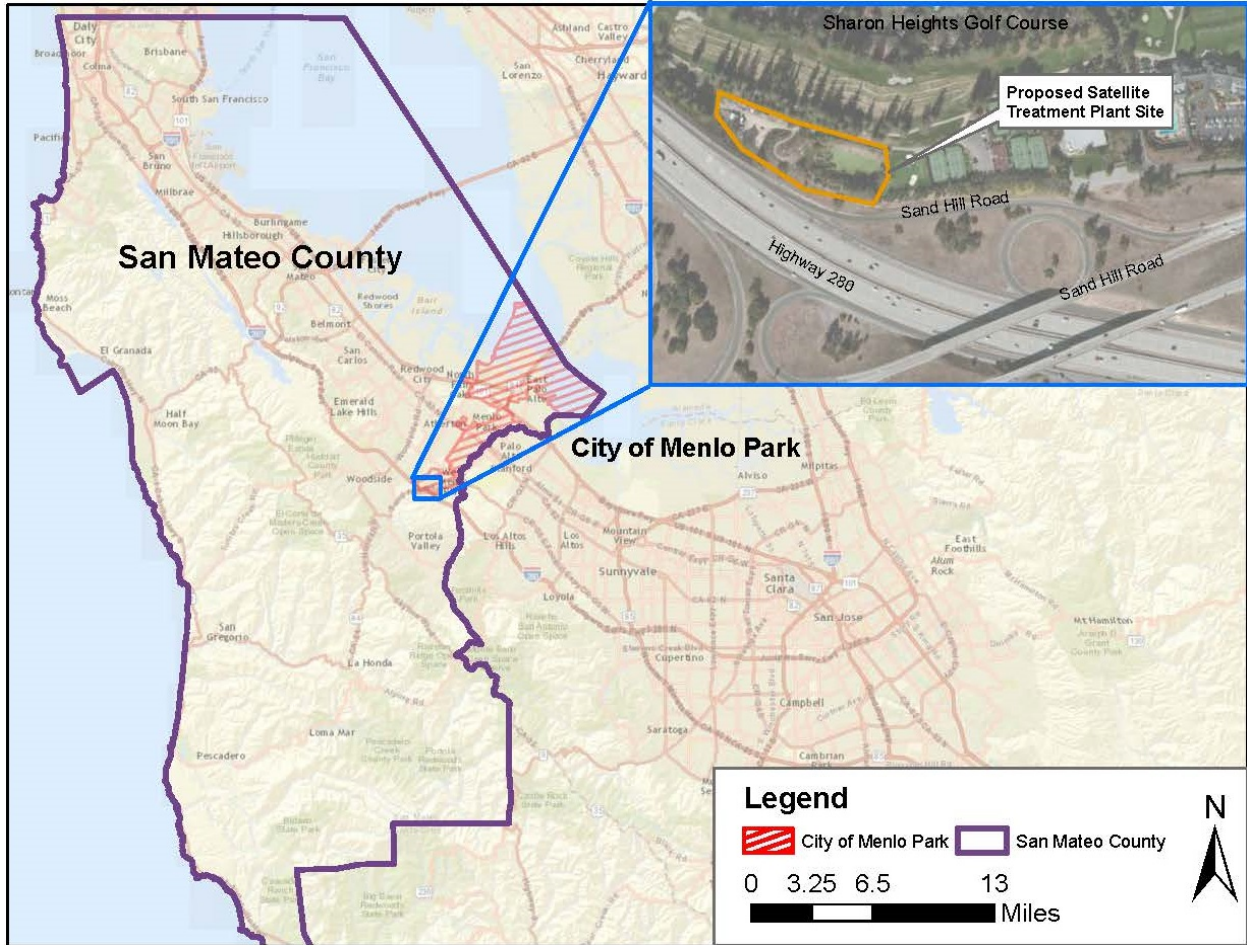

2.1.3 Water Demands

Recycled water annual demands for Phase I and Phase II users are summarized in Table 2.1-1. Demands were modified from the Market Survey by examining irrigation water records for SHG&CC and by updated usage values provided by SLAC.

Table 2.1-1: Recycled Water Demands

Customer Name	Usage Type	RW Annual Demand (AFY)
Phase I		
SHG&CC	Golf Course Irrigation	152
SLAC	Irrigation	25 ¹
SLAC	Cooling Tower	59 ¹
Phase II		
Rosewood Sand Hill	Irrigation	24
Sand Hill Commons	Irrigation	11
Sharon Land Co	Irrigation	10

Footnotes:

1. Based on assumed seven months of recycled water delivery

2.2 Proposed Project Components

Phase I project components include a wastewater pump station and conveyance pipeline, grit removal, fine screens, membrane bioreactor (MBR) system, ultraviolet (UV) disinfection, process and cleaning chemicals, electrical substations, solids disposal pipeline, effluent pump station and recycled water conveyance pipeline. Phase II project components include recycled water distribution pipelines. The process flow schematic for the project is shown on Figure 2.2. Detailed descriptions of the processes are provided in the following sections.

Figure 2.2-1: Sharon Heights Satellite Facility Project Process Flow Schematic

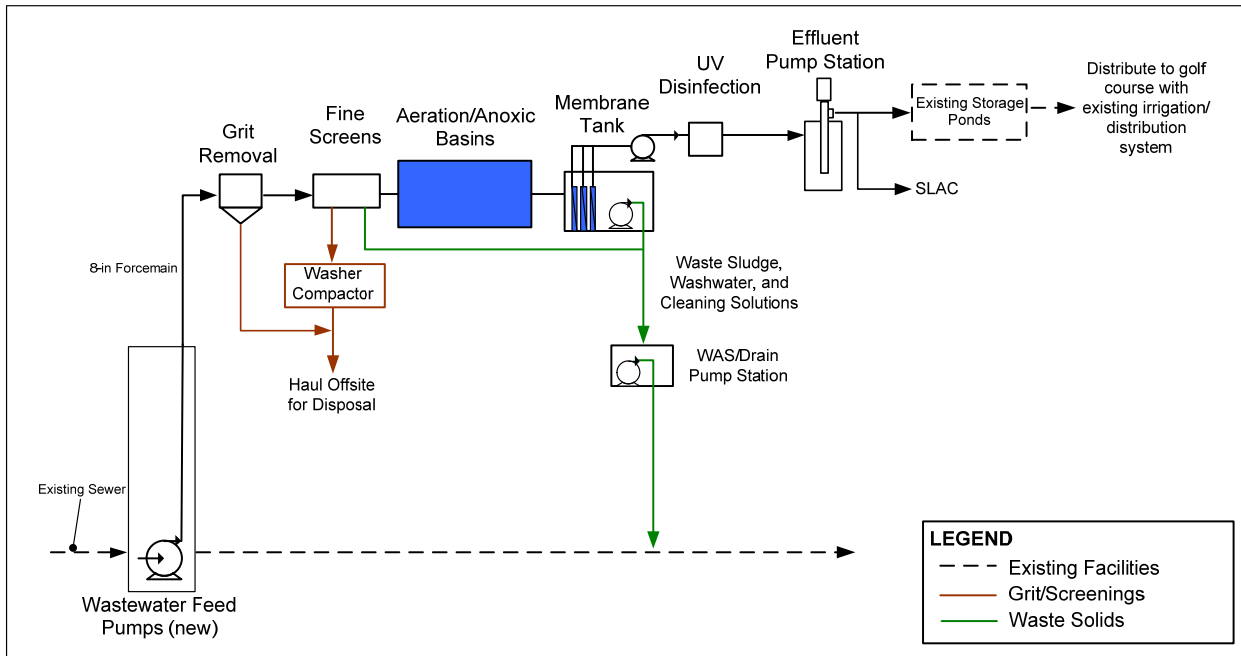

2.2.1 Pipelines

Influent Wastewater Pipeline

The influent wastewater forcemain would require approximately 10,600 linear feet (LF) of 8-inch PVC pipe to deliver wastewater from the influent pump station to the treatment facilities. Figure 2. shows the proposed alignment for the pipe which would be installed in Sand Hill Road within the road right-of-way.

The influent wastewater pipeline will cross the Hetch-Hetchy right-of-way at the intersection of Sand Hill Road and Sharon Park Drive. SFPUC and Division of Drinking Water requirements for the crossing are discussed below.

Note that there is an existing, but abandoned, Pacific Gas & Electric (PG&E) pipeline located in Sand Hill Road. While no details of the exact location and condition of the PG&E pipeline were available, the potential use of this pipeline should be investigated during design as a measure to reduce capital costs of the project. Reuse of the abandoned pipeline would require less excavation and thus result in less impact from project construction.

Recycled Water Distribution Pipelines

The Phase I recycled water distribution pipelines would require approximately 5,300 LF of 6-inch PVC pipe along Sand Hill Road to deliver recycled water from the treatment facility site to SLAC. It was assumed that the storage pond pumps discussed above would connect to existing pipes to deliver recycled water to the existing two million gallon open reservoir at SHG&CC.

The Phase II recycled water distribution pipelines would require approximately 6,340 LF of 6-inch PVC pipe to deliver recycled water from the treatment facilities to the Rosewood Sand Hill, Sand Hill Commons and Sharon Land Co. Figure 2.2-2 shows the proposed alignments for the Proposed Project pipelines.

Solids Discharge Pipeline

Solids produced by membrane separation will be discharged to an existing sewer by gravity. The solids discharge pipeline would require approximately 1,600 LF of 6-inch PVC pipe and will run along the southwestern boundary of the golf course to connect to an existing sewer within the SHG&CC property as shown in Figure 2.2.

Figure 2.2-2: Proposed Pipeline Alignments

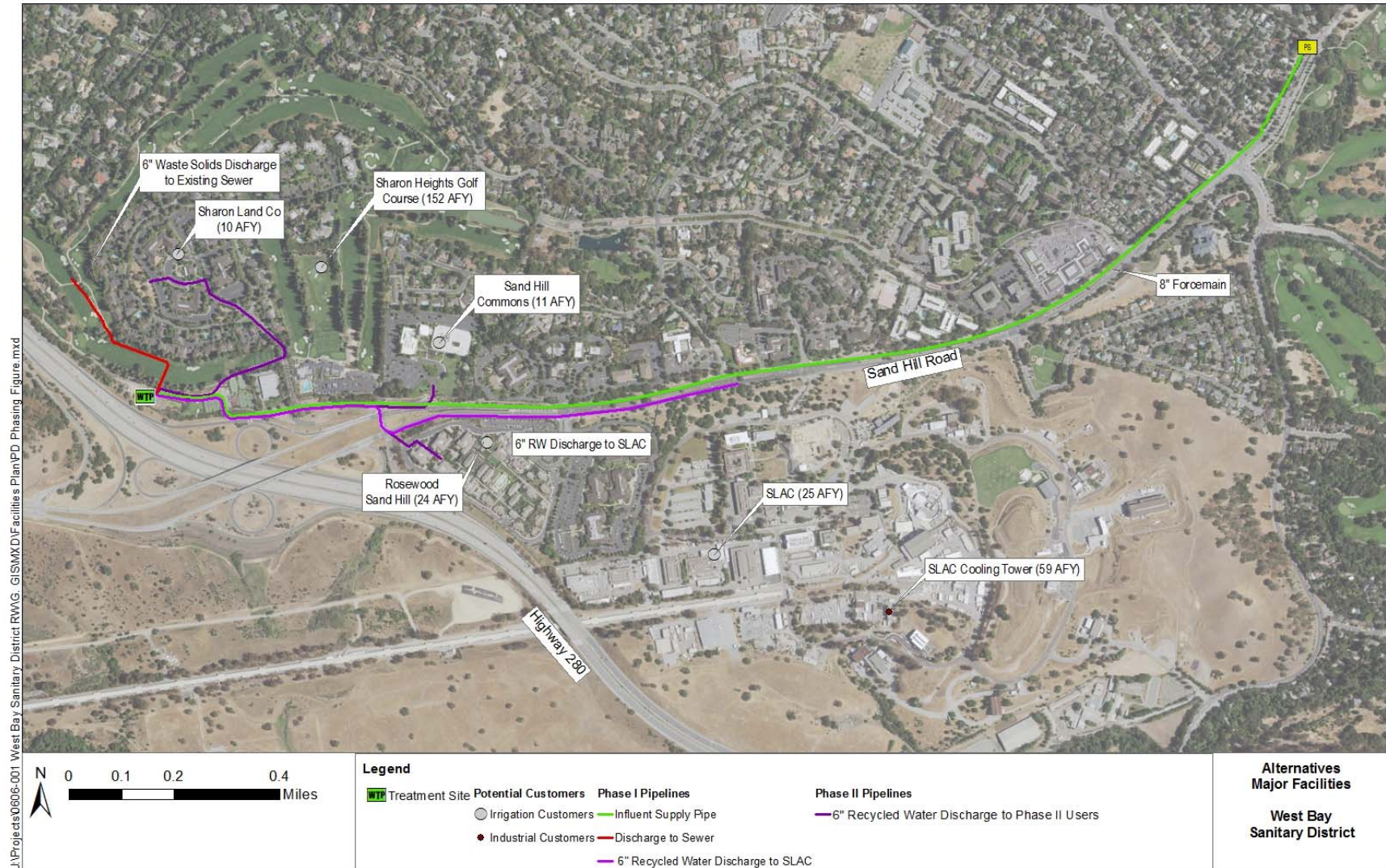

2.2.2 Wastewater Treatment

The proposed WWTP would be located on a 130 ft by 160 ft building site. The concrete masonry block structure would have a 55 ft by 106 ft footprint and a depth of approximately 20 ft. The treatment building would be approximately 20 ft high. Disinfection and effluent pumping facilities would be located separate from the main treatment facilities on a 100 ft by 100 ft building site. The disinfection and effluent wet well structure would be located below grade and would have a 26 ft by 55 ft total footprint and a depth of approximately 15 feet. The facility would be surrounded by vegetation, fencing, or walls to screen views of the site and to integrate it with the existing landscape. **Error! Reference source not found.** shows the project site and location of treatment facilities. The WWTP would contain the following treatment processes and equipment.

Grit Removal

Grit removal is critical to the protection of downstream processes as inert particles present in wastewater, such as sand and gravel, can cause unnecessary abrasion and wear on mechanical equipment. Grit removal will be a mechanical vortex system and will include a grit tank, motor driven rotating paddle, grit pumps and grit classifier.

Fine Screens

Degritted wastewater will be screened through a 2 millimeter (mm) self-cleaning fine screen prior to the MBR system. The screen will serve to protect the downstream membranes by removing particulates, stringy material and other debris which might cause premature membrane fouling.

Membrane Bioreactor

A MBR combines secondary treatment with tertiary filtration using ultrafiltration (UF) or microfiltration (MF) membranes. The system will include below grade concrete bioreactor tanks with anoxic and aerobic zones, membranes and membrane tank, permeate pumps, mixed liquor pumps, process and membrane blowers and cleaning system. The secondary biological process of an MBR is designed to meet the nutrient water quality objectives of a project (e.g., total nitrogen), and the membranes, in lieu of secondary clarification, provide solids liquid separation.

To prevent rapid increases in transmembrane pressure, the membranes will periodically use a combination of backwashing permeate and chlorinated permeate through the membranes to dislodge solids off the surface and to prevent biological growth and fouling on the membrane surface. When the transmembrane pressure reaches an upper limit, a chemical clean is typically performed which consists of rinsing or soaking the membranes for an extended duration (on the order of 4 to 8 hours) in an acid solution (for removal of inorganic fouling) followed by a base or chlorine solution (for removal of biological fouling). A citric acid dosing system to remove inorganic scaling and hypochlorite dosing system to remove organic fouling will be furnished for cleaning and a pH adjustment system utilizing caustic soda (sodium hydroxide) will be included to increase effluent alkalinity. Chemicals will be delivered in totes and will be stored under the treatment shelter.

During the chemical cleaning, the membranes are out of service and do not produce permeate. Depending on the MBR manufacturer and operating details, the membrane cassettes may need to be lifted out of the membrane tanks periodically for inspection, cleaning and/or replacement.

UV Disinfection

UV light has germicidal properties that with the proper dosage have proven to be an effective disinfectant for bacteria, protozoa, and viruses in recycled water. UV disinfection emits UV light at wavelengths that are absorbed by and destroy molecular bonds in the DNA or RNA of microorganisms. The membrane

permeate will be disinfected in an in-vessel UV unit and will meet Title 22 requirements for disinfected tertiary recycled water.

Electrical Substation

The service transformer would be located outside of the treatment building on a 6 ft by 6 ft concrete pad at a height of approximately 7 ft. Other ancillary electrical equipment (switchboard, main switchgear) would be located within the treatment building.

Figure 2.2-3: Treatment Facilities



Recycled Water Pump Station

The recycled water pump station would be located at the effluent wet well adjacent to UV disinfection facilities. The pump station would be a below-grade structure with a footprint of 10 ft by 26 ft and a depth of approximately 15 ft. Two sets of vertical turbine pumps will deliver water to SLAC and the existing SHG&CC storage ponds. Figure 2.2-3 shows the pump station relative to the treatment facilities. Number of pumps, pump capacity, and horsepower are summarized in Table 2.2-1.

Table 2.2-1: Pump Station Summary

Pump Station	No. of Duty Pumps	No. of Standby Pumps	Flow per Pump (gpm)	Motor Size per Pump (hp)	Delivery Pressure (psi)	Pump Station Footprint
Wastewater Pump Station						
Influent Wastewater Pumps	1	1	560	45	-	7-foot diameter
Recycled Water Pump Station						
Storage Pond Pumps	1	1	833	10	-	10 ft by 26 ft
SLAC Pumps	1	1	236	20	70	10 ft by 26 ft

2.3 Operation and Maintenance Requirements

The Proposed Project would be operated by WBSD either directly or through a contract with a professional company providing WWTP operation services. It is expected that the equivalent of two full-time staff (equivalent to 40 hours per week per staff member) would be required to operate the treatment facility. In general, elements of the Proposed Project’s operations and maintenance (O&M) would include proactive, preventive, and corrective maintenance of pump stations, forcemains and the recycled water pressurized system. Overall, the system would be maintained to protect the quality of water in the system, to minimize replacement costs of equipment, minimize the potential for leaks, breaks, overflows, maintain injection/percolation capacity or other situations that would affect the health and safety of the staff, the customers, and the public.

2.3.1 Pipelines

Influent Wastewater Pipeline

The influent wastewater forcemain would be inspected by observing the surface over the pipe to detect any leaks or settlement. All air release valves on the forcemain would be inspected quarterly with air release valves checked for leaks weekly as part of the pipeline visual inspections. Annual performance testing would be required to verify meter calibration, and calibrate pressure gages.

Recycled Water Distribution Pipelines

WBSD, or its maintenance contractor, would perform inspections to observe any anomalies, leaks, or unusual circumstances at the connection from the treatment plant to ensure that the connection is operable and functioning properly. The recycled water pipeline would normally be inspected weekly by observing the surface over the pipe to detect any leaks or settlement. Recycled water pipes are designed for a lifetime measured in decades, therefore very little maintenance of the pipe itself is anticipated. Isolation valves on the system would be exercised and logged on an annual basis. Table 2.2 is a summary of the general maintenance guidelines for the recycled water pipelines.

Table 2.2-1: Recycled Water Pipeline General Maintenance Schedule

Item	Frequency	Action
Pipeline	Variable (upon discovery of issues); One Year	Shut down, drain and disinfect pipeline if there are odor, color, or turbidity issues. Flush dead-end pipes. If odor, color or turbidity issues exist; then disinfect pipe.
Isolation Valves (Gate and Butterfly)	One Year	Refer to equipment manufacturer's operation and maintenance manuals for proper maintenance, lubrication and regular exercising of valves. Repair as-necessary. Unless noted otherwise in the Manufacturer's O&M manual, valves shall be inspected and exercised annually.
Control and Pressure Regulating Valves	Six Months	Visually inspect for leakage. Clean, repair or replace according to Manufacturer O&M.
	One Year	Annually remove valve from service; inspect float for leaks, and pins and linkage for corrosion; remove corrosion products; clean orifices.
Blowoffs	One Year	Inspect and test blowoff assemblies. Repair as necessary. Maintenance of the gate valve shall be as described above for isolation valves.
Air Valves	Six Months	Visually inspect for leakage. Clean, repair or replace according to Manufacturer O&M.
	One Year	Annually remove valve from service; inspect float for leaks, and pins and linkage for corrosion; remove corrosion products; clean orifices.
Backflow Preventers	One Year	Clean all parts thoroughly after disassembly. Carefully inspect rubber seal rings and o-rings for damage.
Services	One Year	Inspect services for leaks, exercise isolation valves. Repair as necessary.
	Two Years	Inspect and test/calibrate meters

Meters would be inspected on a regular basis. Reading of meters provides an opportunity to observe the integrity of the valves, connections, and the meter. Meters would be replaced or refurbished according to the manufacturer's recommendations.

Solids Discharge Pipeline

The gravity flow solids discharge pipeline would be cleaned on a routine schedule. As WBSD begins to collect and analyze maintenance data collected during preventative cleaning, the frequency of sewer cleaning would be adjusted accordingly. Close circuit television (CCTV) would be used to visually inspect the pipeline should any blockages occur and for future condition assessments. As the pipe for this project would be in new condition with no defects, CCTV inspection frequency would be approximately 20 years.

2.3.2 Wastewater Treatment Plant

In general, maintenance at the WWTP site would consist of regular monitoring, sampling and analyses. Plant operations will require that screenings and grit be trucked offsite two times per week and that chemicals be brought onto the site two times a month. Approximately one 55-gal chemical drum each of sodium hypochlorite and citric acid are anticipated to be delivered two times per month (24 chemical delivery trips annually).

Periodic maintenance at the plant includes lifting the membranes every two to three months for inspection, replacing the membranes every 8 to 10 years, periodically changing out UV lamps (as the bulbs burn out), and maintaining the storage reservoirs. This would result in approximately 104 truck trips annually for screening and grit removal.

2.3.3 Pump Stations

Typical pump station operational and maintenance activities would include weekly inspections with wet wells cleaned quarterly. Annual performance testing would also be required to verify meter calibration, and calibrate pressure gages. Preventive maintenance for mechanical and electrical equipment would be scheduled annually. Completed work would be recorded using daily logs that are maintained by the contractor.

2.4 Construction Considerations

Construction of the Phase I facilities are expected to take approximately 13 months beginning in July 2017. Construction of the treatment facility, pump stations, and pipeline would occur concurrently. Construction of each type of facility is described in more detail below. Construction of the Phase II pipelines are dependent on the availability of water and are anticipated in late 2018/early 2019.

In order to comply with the Bay Area Air Quality Management District (BAAQMD) thresholds for air emissions, the Proposed Project will undergo phased construction. The first phase will involve construction of the treatment facilities and two pump stations beginning in July 2017. Following the completion of the pump stations five and a half months later in January 2018, the pipeline construction will begin coinciding with continued work on the WWTP. The WWTP will be completed seven and a half months later in August, with the pipeline completion occurring in late June 2018. The Phase II recycled water pipelines would be constructed no earlier than 2019, with construction lasting approximately two months.

2.4.1 Pipeline Construction

Pipeline installation for all new pipelines would use standard open-cut trenching techniques, except where necessary to avoid surface features and would conform to all WBSD construction specifications. The solids discharge pipeline would be constructed on SHG&CC property. The wastewater conveyance pipeline and recycled water pipeline to SLAC would be constructed on public roadways owned by the City. Construction methodologies are described below.

Open Cut Construction

For all work activities, prior to the start of construction, the construction boundary and the locations of all underground utilities would be identified through field survey (potholing) and the use of Underground Service Alert.

Staging Areas

At various locations along the construction route(s), staging areas would be required to store pipe, construction equipment, and other construction-related material. Staging areas would be established along the route where space is available, such as vacant lots, roadway turnouts, and parking lots. Pipelines near the treatment facility would use that site for staging. Certain staging areas may be used for the duration of project construction due to their favorable location in terms of convenient access and lack of sensitive receptors. In other cases, as pipeline construction moves along the route, staging areas may also be moved to minimize hauling distances and avoid disrupting any one area for extended periods of time. Potential staging areas include vacant private and public land, parking lots, and segments of closed traffic lanes. WBSD or its contractor would make short-term arrangements for the use of staging areas.

Surface Preparation

Surface preparation involves removing any structures (such as fences), pavement, and/or vegetation from the trench area. Equipment used for this activity includes jack hammers, pavement saws, graders, bulldozers, loaders, and trucks.

Trench Excavation/Shoring

A backhoe, excavator, or trencher would be used to dig trenches for pipe installation. In general, trenches would have vertical side walls to minimize the amount of soil excavated, and the area needed for the construction easement. Soils excavated from the trenches will all be hauled off site for disposal. Disposal options include use as cover material at sanitary landfills and use as “clean fill” at other sites.

The maximum trench width (for a 6- to 8-inch pipeline) would be approximately 3 feet, and trench depth would average approximately 6 feet. The active work areas would be about 10 feet on one side of the trench and about 10 to 15 feet on the other side for access by trucks and loaders. For the purpose of this analysis, a construction easement of 30 feet is assumed. Standard installation of the pipeline would proceed at the rate of approximately 150 to 300 feet per day.

Pipeline trenches, in any given location, would be open for two to three days on average. During construction, vertical wall trenches would be temporarily “closed” at the end of each work day, by covering with steel plates or backfill material.

Trenches would be backfilled with imported material. Dump trucks would be used to deliver imported, engineered backfill material to stockpiles near the trenching operation. For the pipelines, it is assumed that approximately 53 cubic yards (CY) of soil export would be required for each 100-foot segment of influent pipeline installed, 49 CY for each 100-foot segment of recycled water distribution pipeline installed, and 49 CY for each 100-foot segment of solids discharge pipeline installed.

Surface Restoration

The final step in the installation process would be to restore the ground surface. When the pipe is installed in a paved roadway, repaving would occur after construction. New asphalt or concrete pavement would be placed to match the surrounding road type. For asphalt repaving, a temporary asphalt material may be installed to allow traffic to use the roadway immediately after pipeline construction. A repaving crew would follow the pipe installation crew and prepare the road surface for repaving. Final repaving would be done after pipe installation was completed for a whole street width, lane width, or trench width.

Trenchless Construction Techniques

The project would require one major crossing – an east to west crossing of the Hetch-Hetchy right-of-way at the Sharon Park Drive intersection by the influent forcemain in Sand Hill Road. SFPUC and Division of Drinking Water (DDW) requirements for the crossing are further discussed below. As an alternative to open-cut construction, trenchless techniques such as horizontal directional drilling (HDD) may be employed.

Horizontal Directional Drilling

HDD crossings are installed by using a drill rig, with the top of the drill rig tilted up at to an angle of approximately ten degrees from horizontal. The bore entry holes are drilled from the starting point to the destination point. In preparing the hole, a small diameter (3-inch-wide) pilot hole is first drilled in a gentle arc from the drill rig to the completion hole on the other side of the area to be crossed. This pilot hole can be guided using magnetic readings transmitted from the drill bit back to the drill rig. After the initial hole is drilled, the final bore entry pit, approximately 10 ft square by approximately 8 ft deep, is constructed and is used as the collection point for Bentonite drilling mud and drill spoil. During the directional drill

procedure, drilling mud is injected into the drill and recovered from the entry hole until the drill bit surfaces at the exit pit. Once the drill bit surfaces, the drilling mud is recovered at both the entry and exit hole, pumped into tanks and transported back to the rig location for cleaning and eventual reuse. The proposed pipeline is pulled back through the hole while simultaneously back-reaming the pilot hole (making the hole larger) so it can accommodate the proposed pipeline. Using this technique, the ground surface would not be disturbed except at the pits.

Hetch-Hetchy Crossing

The Proposed Project would require one major crossing – an east to west crossing of the Hetch-Hetchy right-of-way at the Sharon Park Drive intersection by the influent forcemain in Sand Hill Road. Utilities crossing SFPUC pipelines must have a minimum clearance of 12-inches for open excavation, 24-inches for directional boring operation. All crossings must be as close to perpendicular as possible. All sewer and recycled water crossings must comply with DDW requirements:

- When a sewage forcemain must cross a water main, the crossing should be as close as practical to the perpendicular. The sewage force main should be at least one foot below the water main.
- When a new sewage forcemain crosses under an existing water main, and a one-foot vertical separation cannot be provided, all portions of the sewage force main within eight feet (horizontally) of the outside walls of the water main should be enclosed in a continuous sleeve. In these cases, a minimum vertical separation distance of 4 inches should be maintained between the outside edge of the bottom of the water main and the top of the continuous sleeve.

2.4.2 WWTP Construction

Construction of the WWTP would include the adjacent recycled water pump station and would involve several steps, as follows.

Site Preparation

This would involve clearing, grubbing and other site preparation activities.

Earthwork

After the site is cleared of underbrush and trees, grading would begin. The contractor would attempt to minimize both cut and fill quantities within the construction area to the extent feasible in order to minimize the net export or import of soils from the site. Material excavated would be off hauled and all fill would be imported. Following rough grading, additional excavation would bring the site to final grade and allow for preparation for underground piping and structural slabs.

Approximately 11,000 CY of excavated materials would be offhauled from the project site, 2,000 CY of which are for the effluent pump station and associated disinfection facilities. Assuming a truck capacity of 20 CY, offhaul of excavated materials would require approximately 550 truck trips. Additional site work would include paving, temporary and permanent security fencing, and site lighting.

Structural Improvements

Prior to pouring concrete, structural forms, rebar, and conduits would be installed for the facility. After the concrete is poured, it would be finished and cured before the forms are removed. For structures, after the concrete footing, slab, and walls are poured, the overhead structural steel and roof decking would be erected. For tanks, after the foundation is poured, the steel tank is erected over the foundation slab.

Electrical/Instrumentation

After the structures are erected or retrofitted, electrical equipment (e.g., machinery control consoles, switchboards, and lighting) would be installed. Site work such as installing pull boxes, conduits, and cables would continue. After roofs on the buildings and facilities are secured, flow meters, level probes, pressure meters, process analyzers, and other instrumentation would be installed. Additionally, water quality adjustment, sampling, and monitoring equipment would be installed.

Startup and Testing

This phase of construction would involve WBSD personnel (i.e., engineers, inspectors, operators, maintenance crews, and instrumentation specialists) working with the equipment vendors to understand how each piece of equipment would operate and function. Under WBSD supervision, the construction contractor would start up and test the equipment on site to guarantee that pumps, motors, monitoring and communication equipment are functional and able to meet design standards.

2.4.3 Pump Station Construction

Pump station construction would involve several steps, as follows.

Site Preparation

This would involve site preparation activity, as needed. A Traffic Control Plan would be prepared and implemented to minimize impacts on traffic and maintain traffic flow during pump station construction.

Earthwork

It is expected that the contractor would attempt to balance cut and fill quantities within the construction area to the extent feasible. Approximately 20 CY for the influent wastewater pump station of excavated materials would be offhauled from the respective site. Assuming a truck capacity of 20 CY, offhaul of excavated materials would require approximately 1 truck trip for the influent pump station. Additional site work would include paving, temporary and permanent security fencing, and screening.

Structural Improvements

Prior to pouring concrete, structural forms, rebar, and conduits would be installed for the facility. After the concrete is poured, it would be finished and cured before the forms are removed. For structures, after the concrete footing, slab, and walls are poured, the overhead structural steel and decking would be erected.

Electrical/Instrumentation

After the structures are erected and all related equipment installed, electrical equipment (e.g., machinery control consoles) would be installed. Site work such as installing pull boxes, conduits, and cables would continue, followed by the installation of, flow meters, level probes, pressure meters, process analyzers, and other instrumentation.

Startup and Testing

This phase of construction would involve WBSD personnel (i.e., engineers, inspectors, operators, maintenance crews, and instrumentation specialists) working with the equipment vendors to understand how each piece of equipment would operate and function. Under WBSD supervision, the construction contractor would start up and test the equipment on site to guarantee that pumps, motors, monitoring and communication equipment are functional and able to meet design standards.

2.4.4 Planned Traffic Controls

Traffic Control Plans would be prepared and implemented to minimize traffic impacts and maintain traffic flow during construction of Proposed Project facilities. The plans would include the following:

- Provisions for maintaining access to all properties along roadways affected by pipeline construction;
- Plans for maintaining traffic flow on roadways where temporary lane closures are necessary;
- Designated haul routes that minimize traffic on local streets;
- Limits on hours of truck deliveries and construction in Sand Hill Road in compliance with City of Menlo Park;
- Coordination with facility owners or administrators of sensitive land uses such as schools, including advance notification of timing, location and duration of construction activities and locations of any detours or lane closures;
- Requirements for notification of emergency service providers, and provision for emergency access; and,
- Provision for construction worker parking that would not reduce availability of parking in the project area.

2.5 Responsible Agencies, Permits and Approvals

The potential permits and/or approvals from other agencies that may be required prior to construction of the proposed project are listed below:

- State Water Resources Control Board:
 - General Construction Permit (Order 2009-0009-DWQ)
 - General Water Discharge Requirements for Recycled Water Use (WQ 2014-0900-DWQ)
- City of Menlo Park:
 - Encroachment and Excavation Permit
 - Street Work Permit
 - Conditional Use Permit⁸
- California Department of Transportation: Encroachment Permit
- BAAQMD: General Permit to Construct

⁸ As a sanitary district organized and existing under the Sanitary District Act of 1923 (Cal. Health & Safety Code §6500, et seq.), WBSD also has independent authority to “acquire, plan, construct, reconstruct, alter, enlarge, law, renew, replace, maintain, and operate ... water recycling and distributions systems” within its jurisdictional boundaries.

This page intentionally left blank

Chapter 3 Environmental Checklist

3.1 Aesthetics

Would the Project:	<u>Potentially Significant Impact</u>	<u>Less Than Significant With Mitigation Incorporation</u>	<u>Less Than Significant Impact</u>	<u>No Impact</u>
a) Have a substantial adverse effect on a scenic vista?	<input type="checkbox"/>	<input type="checkbox"/>	<input checked="" type="checkbox"/>	<input type="checkbox"/>
b) Substantially damage scenic resources, including, but not limited to, trees, rock outcroppings, and historic buildings within a state scenic highway?	<input type="checkbox"/>	<input checked="" type="checkbox"/>	<input type="checkbox"/>	<input type="checkbox"/>
c) Substantially degrade the existing visual character or quality of the site and its surroundings?	<input type="checkbox"/>	<input checked="" type="checkbox"/>	<input type="checkbox"/>	<input type="checkbox"/>
d) Create a new source of substantial light or glare which would adversely affect day or nighttime views in the area?	<input type="checkbox"/>	<input type="checkbox"/>	<input checked="" type="checkbox"/>	<input type="checkbox"/>

Discussion

- a) The City of Menlo Park is in the process of updating their General Plan under the ConnectMenlo General Plan program. There are limited scenic vistas within the City of Menlo Park (City of Menlo Park, 2013). The proposed WWTP would be located on the grounds of SHG&CC and not in a publically accessible vantage point.

In its draft Community Character Report (2015), the City has identified the stretch of Sand Hill Road from Santa Cruz Avenue to Highway 280 as a View Corridor, which is characterized as short-, middle-, and long-range views (City of Menlo Park, 2015). This view corridor in the Study Area is along a tree-lined stretch of Sand Hill Road and at the western-most section of the corridor. Impacts to the view corridor are minimized to less than significant by the low profile of planned project facilities, screening structures, and coverage provided by trees between the Propose Project and Sand Hill Road.

Construction of the pipeline along Sand Hill Road may have temporary impacts on the scenic attributes of the View Corridor, but those impacts will only exist during the construction phase of the project. All in-street pipeline infrastructure will be below grade and will not have lasting aesthetic impacts. As part of construction completion, impacted streets will be restored to their pre-construction condition. Potential effects on scenic vistas are considered less than significant.

- b) Within the Study Area, there is one officially designated State Scenic Highway (I-280) located immediately adjacent (to the west) to the Proposed Project. Impacts to the scenic resources are minimized to less than significant by the low profile of planned project facilities, the overall size of the WWTP, the speed of traffic on I-280, screening structures, and coverage provided by trees between the project and Interstate 280. Impacts to scenic resources are considered less than significant with anticipated project design and **Mitigation Measure AES-1**.

Mitigation Measure AES-1: Design, Vegetation, and Screening of Project Facilities

Design of the proposed above-ground facilities (namely the WWTP) shall be compatible with surrounding neighborhood and structures. Vegetation and/or fencing shall be placed around the WWTP to provide screening if existing vegetation is deemed insufficient. Landscaping will include re-vegetation of disturbed areas to minimize contrasts with the existing vegetation and to screen facilities from surrounding neighborhoods. Proposed facilities shall be painted low-glare earth-tone colors that blend with the surrounding terrain.

- c) The Proposed Project would be constructed on what is undeveloped, but previously disturbed, land within the existing SHGC&CC site (zoned as OSC) and within roadway ROWs. Treatment basins at the WWTP would be constructed below grade, in a previously disturbed area. The facility site would be would have a 130 ft by 160 ft footprint and be located on terrain that would require grading. Disinfection and effluent pumping facilities would be located separate from the main treatment facilities on a 100 ft by 100 ft building site. The disinfection and effluent wet well structure would be located below grade and would have a 26 ft by 55 ft total footprint and a depth of approximately 15 feet. The electrical substation would be less than 10 feet tall.

The majority of structures and equipment would be concealed from views from the west, south, and east due to the presence of trees between the roads and the new facilities. Most of the structures are also not anticipated to be visible from the north, as they would also be concealed by existing trees and land topography, except from the existing private road and golf cart path. Trees meeting the “heritage tree” definition of the City’s Heritage Tree Ordinance would be avoided during construction. Tree removal is not expected as part of the Proposed Project, however any heritage trees requiring removal or major pruning would require additional permitting from the City.

Although the visual quality of the site would change with the Proposed Project, and facilities would be visible to private views from certain points, proposed structures would be screened to integrate with the existing landscape. The facility would be surrounded by vegetation, fencing, or walls to screen views of the site and to integrate it with the existing landscape. **Mitigation Measure AES-1** will reduce potential impacts to less than significant.

Construction of the WWTP would create temporary visual impacts, but these impacts would be short-term in nature. Construction of the distribution and influent pipelines would temporarily alter the visual character along the roadways and in parts of the golf course, but roadways would be restored to pre-construction conditions upon completion, creating no significant long-term visual impacts along the roadways. Ground disturbance in the golf course would also be restored to pre-construction conditions upon completion.

Finally, conceptual layout of the treatment processes (see Chapter 2) demonstrates that facilities can fit into the available space at SHG&CC and not visually or physically impact the existing golf course operations beyond the temporary construction activities. New facilities will be sited on the outer edge of the golf course, and will use vegetation and design to minimize visibility. The Proposed Project would not degrade the visual character of the site and potential impacts are considered less than significant.

- d) The Proposed Project proposes the installation of outdoor, permanent lighting at proposed facilities for security purposes. These lights would be directed downward and oriented so that lights would not be directly visible from neighboring residences, or located on the sides of the buildings away from neighboring residents, to minimize light and glare effects. Given the design features, potential impacts related to light and glare are expected to be less than significant.

3.2 Agriculture and Forestry Resources

Would the Project:	<u>Potentially Significant Impact</u>	<u>Less Than Significant With Mitigation Incorporation</u>	<u>Less Than Significant Impact</u>	<u>No Impact</u>
a) Convert Prime Farmland, Unique Farmland, or Farmland of Statewide Importance (Farmland), as shown on the maps prepared pursuant to the Farmland Mapping and Monitoring Program of the California Resources Agency, to non-agricultural use?	<input type="checkbox"/>	<input type="checkbox"/>	<input type="checkbox"/>	<input checked="" type="checkbox"/>
b) Conflict with existing zoning for agricultural use, or a Williamson Act contract?	<input type="checkbox"/>	<input type="checkbox"/>	<input type="checkbox"/>	<input checked="" type="checkbox"/>
c) Conflict with existing zoning for or cause rezoning of, forest land (as defined in Public Resource Code section 12220 (g)), timberland (as defined by Public Resource Code section 4526), or timberland zoned Timberland Production (as defined by Government Code section 51104(g))?	<input type="checkbox"/>	<input type="checkbox"/>	<input type="checkbox"/>	<input checked="" type="checkbox"/>
d) Result in the loss of forest land or conversion of forest land to non-forest use?	<input type="checkbox"/>	<input type="checkbox"/>	<input type="checkbox"/>	<input checked="" type="checkbox"/>
e) Involve other changes in the existing environment which, due to their location or nature, could result in conversion of Farmland, to non-agricultural use or conversion of forest land to non-forest use?	<input type="checkbox"/>	<input type="checkbox"/>	<input type="checkbox"/>	<input checked="" type="checkbox"/>

Discussion

a-e) According to the Farmland Mapping and Monitoring Program (FMMP) map for San Mateo County, the Study Area falls entirely within Urban/Built and Other land designations. There are no Farmlands within the Study Area (California Department of Conservation, 2015). There are no forestry resources within the vicinity of the Study Area (see Figure 3.2-1) (California Department of Conservation, 2015).

Figure 3.2-1: Farmland Mapping and Monitoring Program (FMMP) Land Designation Map

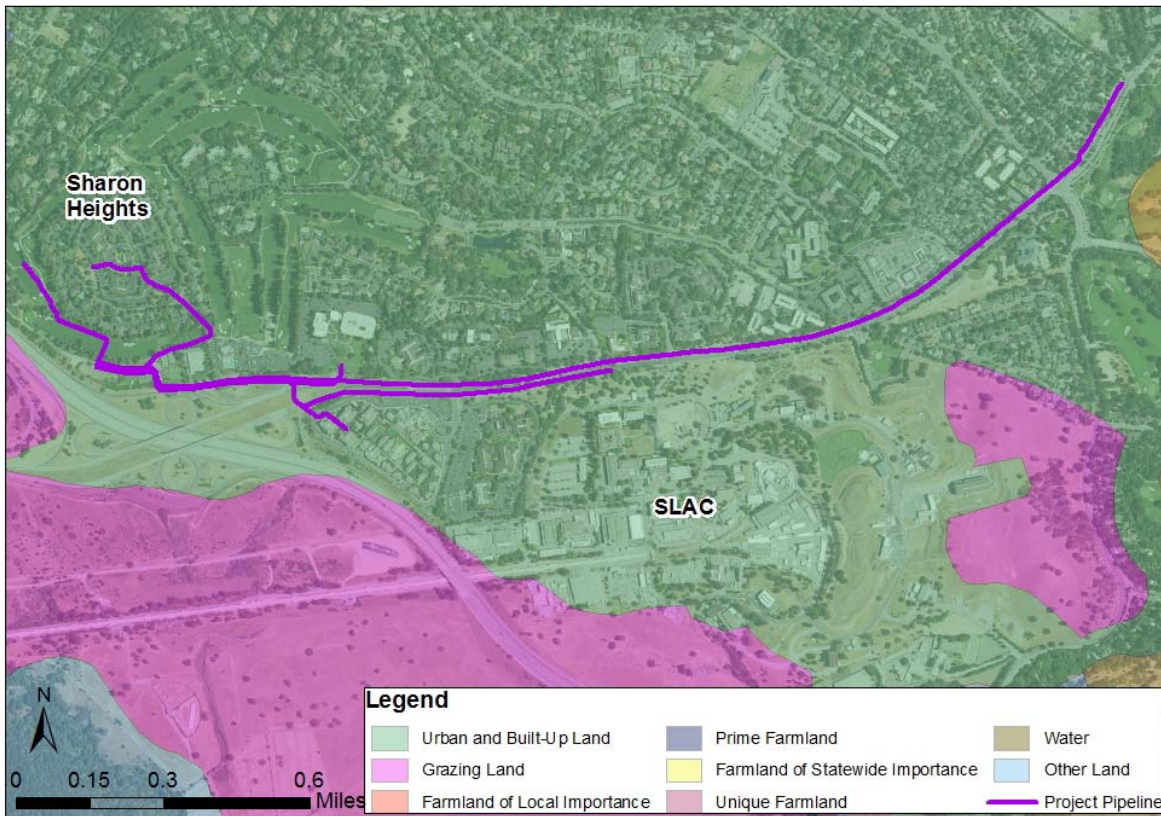

3.3 Air Quality

	<i>Potentially Significant Impact</i>	<i>Significant With Mitigation Incorporation</i>	<i>Less Than Significant Impact</i>	<i>No Impact</i>
Would the Project:				
a) Conflict with or obstruct implementation of the applicable air quality plan?	<input type="checkbox"/>	<input checked="" type="checkbox"/>	<input type="checkbox"/>	<input type="checkbox"/>
b) Violate any air quality standard or contribute substantially to an existing or projected air quality violation?	<input type="checkbox"/>	<input checked="" type="checkbox"/>	<input type="checkbox"/>	<input type="checkbox"/>
c) Result in a cumulatively considerable net increase of any criteria pollutant for which the Project region is non-attainment under an applicable federal or state ambient air quality standard (including releasing emissions which exceed quantitative thresholds for ozone precursors)?	<input type="checkbox"/>	<input checked="" type="checkbox"/>	<input type="checkbox"/>	<input type="checkbox"/>

- | | | | | |
|---|--------------------------|-------------------------------------|-------------------------------------|--------------------------|
| d) Expose sensitive receptors to substantial pollutant concentrations? | <input type="checkbox"/> | <input checked="" type="checkbox"/> | <input type="checkbox"/> | <input type="checkbox"/> |
| e) Create objectionable odors affecting a substantial number of people? | <input type="checkbox"/> | <input type="checkbox"/> | <input checked="" type="checkbox"/> | <input type="checkbox"/> |

Discussion

a,b,c) The Bay Area Air Quality Management District (BAAQMD) does not meet state PM₁₀ standard, the national and state PM_{2.5} standard, and the state 1-hour, state 8-hour and the national 8-hour ozone standards. The Proposed Project’s construction activities would generate dust and criteria pollutant emissions that could, but are not expected to, exceed BAAQMD or Federal Clean Air Act (CAA) General Conformity standards. **Appendix B** contains a General Conformity Air Quality Analysis for the federal Clean Air Act and includes detailed air quality modeling outputs.

Construction

Construction of the proposed WWTP and recycled water effluent pump station is estimated to generate 11,000 cubic yards of soils, or equivalent to 550 truck trips during the course of the 13-month construction period (mid-2017 through mid-2018) assuming 20 cubic yards per truck load. For the purposes of this analysis, it is assumed that excavation would require up to 16 round-trip truck trips per day, 5 days per week, for approximately seven weeks total. The Phase I pipelines will generate an estimated 8,986 yards of soils, or 450 round-trip truck trips. For the purposes of this analysis, it is assumed that excavation would require up to 5 round-trip truck trips per day, 5 days per week, for approximately six months total. The influent pump station will generate an estimated 40 cubic yards of soils, or 2 truck trips. For the purposes of this analysis, it is assumed that excavation would require up to 2 truck trips per day for 1 day. The Phase II pipelines will generate an estimated 3,082 cubic yards of soils, or 155 round-trip truck trips. For the purposes of this analysis, it is assumed that excavation would require up to 5 round-trip truck trips per day, 5 days a week for approximately 6 weeks. Additional incidental truck trips would be necessary for delivery of materials and workers to each of the three project components.

Simultaneous construction of all four project components of Phase I will cause the NO_x daily emission threshold to be exceeded. For this reason, construction will be phased as follows. Construction of Phase I will begin in 2017 with the pump stations and WWTP. Pump stations will be completed early 2018, at which point pipeline installation will begin. Construction of the pipelines and WWTP will be completed in 2018. Construction of Phase II pipelines would occur in late 2018 or early 2019 over a span of approximately two months.

Table 3.3-1 provides a summary of the maximum daily construction emissions for the Proposed Project, along with a summary of the BAAQMD thresholds. **Table 3.3-2** provides a summary of overall annual construction emissions for the Proposed Project, along with the Federal General Conformity thresholds. The Proposed Project has emissions approaching BAAQMD thresholds for NO_x; however, the construction duration and associated emissions contribution will be temporary. As shown, the Proposed Project would not exceed established State/local or federal thresholds for criteria air pollutants and construction-related emissions would be less than significant. Additionally, given the short duration of emissions contribution, the Proposed Project will not contribute considerably to cumulative ozone formation.

Table 3.3-1: Proposed Project Maximum Daily Construction and Operational Emissions

Maximum Daily Construction Emission (lbs/day)						
	VOC	NO_x	CO	SO₂	PM₁₀	PM_{2.5}
Pipeline-Phase 1	4.32	38.65	27.44	-	4.26	2.35
Pipeline-Phase 2	3.77	31.29	26.76	-	3.90	2.05
Pump Station-Wastewater	1.31	12.74	9.11	0.01	1.58	1.13
Recycled Water Treatment Plant (2017)	2.24	21.74	20.54	0.04	2.43	1.52
Recycled Water Treatment Plant (2018)	6.38	11.05	7.97	0.01	0.73	0.66
Total	18.02	115.47	91.82	0.07	12.90	7.71
Phased Maximum	10.70	49.70	35.41	0.05	4.99	3.01
BAAQMD Thresholds ¹	54	54	-	-	82	54
<i>Significant Construction Emissions</i>	NO	NO	-	-	NO	NO
Maximum Daily Operational Emission (lbs/day)						
	VOC	NO_x	CO	SO₂	PM₁₀	PM_{2.5}
Pipeline-Phase 1	-	-	-	-	-	-
Pipeline-Phase 2	-	-	-	-	-	-
Pump Station-Wastewater	0.00	0.00	0.00	0.00	0.00	0.00
Recycled Water Treatment Plant	0.38	0.61	2.48	0.00	0.28	0.08
Power Generation Emissions	NA	1.39	NA	0.08	NA	NA
Total	0.3796	2.00	2.48	0.08	0.28	0.08
BAAQMD Thresholds ¹	54	54	-	-	82	54
<i>Significant Construction Emissions</i>	NO	NO	-	-	NO	NO

¹CEQA Significance Thresholds (BAAQMD 2009)

Table 3.3-2: Proposed Project Annual Construction and Operational Emissions

Overall Annual Construction Emission (tons/year)						
	VOC	NO _x	CO	SO ₂	PM ₁₀	PM _{2.5}
Pipeline-Phase1	0.26	2.31	1.64	0.00	0.18	0.13
Pipeline-Phase2	0.06	0.47	0.40	0.00	0.04	0.03
Pump Station-Wastewater	0.08	0.72	0.52	0.00	0.07	0.05
Recycled Water Treatment Plant	0.11	0.99	0.75	0.00	0.07	0.06
Total	0.50	4.50	3.30	0.00	0.36	0.26
Federal General Conformity Thresholds ¹	100	100	100	100	100	100
<i>Significant Construction Emissions²</i>	NO	NO	NO	NO	NO	NO
Annual Operation Emission (tons/year)						
	VOC	NO _x	CO	SO ₂	PM ₁₀	PM _{2.5}
Pipeline-Phase 1	-	-	-	-	-	-
Pipeline-Phase 2	-	-	-	-	-	-
Pump Station-Wastewater	0.00	0.00	0.00	0.00	0.00	0.00
Recycled Water Treatment Plant	0.06	0.08	0.32	0.00	0.04	0.01
Power Generation Emissions	NA	0.25	NA	0.01	NA	NA
Total	0.06	0.34	0.32	0.01	0.04	0.01
BAAQMD Thresholds ²	10	10	-	-	15	10
Federal General Conformity Thresholds ¹	100	100	100	100	100	100
<i>Significant Construction Emissions</i>	NO	NO	NO	NO	NO	NO

¹ Federal General Conformity Rule.

² CEQA Significance Thresholds (BAAQMD 2009)

Operation

Operation of the Proposed Project is expected to generate minimal emissions from chemical delivery truck trips and operation of the WWTP and pumping facilities. Pumping and treatment facilities will generate indirect emissions from off-site Pacific Gas and Electric power generation facilities. Small electric generator(s) will be operated on-site in case of power loss to maintain power to peripheral systems. Backup generator(s) would only be used in the event that grid power is not available or for backup system testing; the duration of these activities is expected to be minimal and does not require quantification.

Table 3.3-1 provides a summary of the maximum daily operational emissions for the Proposed Project, along with a summary of the BAAQMD thresholds. **Table 3.3-2** provides a summary of overall annual construction emissions for the Proposed Project, along with the BAAQMD and Federal General Conformity thresholds. As shown, the Proposed Project would not exceed established State/local or federal thresholds for criteria air pollutants and operational emissions would be less than significant. Additionally, because of the minimal emissions generated during project operation, it will not have a considerable contribution to cumulative air pollutant exceedances.

Although all air quality emissions from the Proposed Project will fall below established significance thresholds, **Mitigation Measure AIR-1** will be implemented in accordance with the BAAQMD CEQA Air Quality Guidelines (2012) to further reduce project impacts. This includes implementation of dust control measures and/or requiring contractors to implement best available control technology for construction equipment.

Mitigation Measure AIR-1: BAAQMB Air Pollution Control Technologies

WBSD shall direct its construction contractor to implement the “Basic Construction Mitigation Measures” and “Additional Construction Mitigation Measures” in the BAAQMD CEQA Air Quality Guidelines (2012) during construction of the Proposed Project. Air pollution control efforts shall include watering and covering exposed surfaces, minimizing idling times, maintaining and properly tuning all construction equipment, repaving/replanting disturbed surfaces as quickly as possible, and others as applicable. When available, more efficient construction equipment will be procured to minimize NOx and VOC emissions.

Implementation of Mitigation Measure AIR-1 (as recommended in **Appendix B**) would reduce potential impacts to air quality to less than significant levels.

- d) As part of Phase I, the WWTP site would be located on the southwest edge of SHG&CC; the influent pipeline would be constructed along Sand Hill Road, from the golf course to Oak Avenue; the disposal pipeline would be constructed in golf course property; and recycled water distribution piping would be located within the golf course and due east along Sand Hill Road and adjacent frontage road. Trinity School, Stanford Hills Park, SLAC, and some residential units are located along the alignment of the influent and distribution pipelines. Phase II pipeline construction would be located along Sand Hill Road enclosed within the golf course, as well as to two adjacent business parks. Commercial buildings as well as a few residential units are located along the Phase II recycled water distribution piping alignment. Given the short duration of construction, and **Mitigation Measure AIR-1** described above, sensitive receptors¹ at the school and at nearby residences are not expected to be exposed to substantial pollutant concentrations. Thus, impacts are expected to be less than significant.
- e) Construction of the Proposed Project would occur within an urbanized area. The WWTP would be located in Open Space zoning, with the nearest building over 400 feet away, across a fairway on the golf course. Potential objectionable odors may occur at the treatment facility during operation. However, biological basins would be constructed below grade. Given the relatively small size of the treatment facility (0.5 mgd) and design criteria which would keep all treatment operations in the enclosed structure, impacts from operation are expected to be less than significant. There is also potential for some objectionable odors during construction (e.g., diesel fuel), but these would be temporary in nature and considered less than significant.

¹ Sensitive receptors are those locations where sensitive populations are commonly found. Sensitive populations include children, seniors, people with health conditions, and other members of the general public that are at increased risk of negative health effects. Common sensitive receptors include schools, hospitals, retirement and nursing facilities, and child care centers.

3.4 Biological Resources

	<u>Potentially Significant Impact</u>	<u>Less Than Significant With Mitigation Incorporation</u>	<u>Less Than Significant Impact</u>	<u>No Impact</u>
Would the Project:				
a) Have a substantial adverse effect, either directly or through habitat modifications, on any species identified as a candidate, sensitive, or special-status species in local or regional plans, policies, or regulations, or by the California Department of Fish and Game or U.S. Fish and Wildlife Service?	<input type="checkbox"/>	<input checked="" type="checkbox"/>	<input type="checkbox"/>	<input type="checkbox"/>
b) Have a substantial adverse effect on any riparian habitat or other sensitive natural community identified in local or regional plans, policies, and regulations or by the California Department of Fish and Game or U.S. Fish and Wildlife Service?	<input type="checkbox"/>	<input type="checkbox"/>	<input checked="" type="checkbox"/>	<input type="checkbox"/>
c) Have a substantial adverse effect on federally protected wetlands as defined by Section 404 of the Clean Water Act (including, but not limited to, marsh, vernal pool, coastal, etc.) through direct removal, filling, hydrological interruption, or other means?	<input type="checkbox"/>	<input type="checkbox"/>	<input checked="" type="checkbox"/>	<input type="checkbox"/>
d) Interfere substantially with the movement of any native resident or migratory fish or wildlife species or with established native resident or migratory wildlife corridors, or impede the use of native wildlife nursery sites?	<input type="checkbox"/>	<input type="checkbox"/>	<input checked="" type="checkbox"/>	<input type="checkbox"/>
e) Conflict with any local policies or ordinances protecting biological resources, such as a tree preservation policy or ordinance?	<input type="checkbox"/>	<input checked="" type="checkbox"/>	<input type="checkbox"/>	<input type="checkbox"/>
f) Conflict with the provisions of an adopted Habitat Conservation Plan, Natural Community Conservation Plan, or other approved local, regional, or state habitat conservation plan?	<input type="checkbox"/>	<input type="checkbox"/>	<input type="checkbox"/>	<input checked="" type="checkbox"/>

Discussion

- a) Fifty special status plants and animals were evaluated for their potential to occur in the Study Area. **Appendix C** contains a full Biological Resources Assessment (BRA) for the Proposed Project, including a search of the California Natural Diversity Database (CNDDB) records of special status species within five miles of the Study Area. The Study Area contains suitable habitat for only five special status animal species. Three of these animals are listed either under

the Federal Endangered Species Act (FESA) and/or the California Endangered Species Act (CESA). No special status plants are expected to occur within the Study Area.

The Study Area is developed with patches of ruderal habitat and lacks suitable habitat for many special status species. Breeding habitat for California tiger salamander, California red-legged frog, western pond turtle, and San Francisco garter snake are not present in the Study Area; however, the northeastern end of the Study Area is immediately adjacent to suitable breeding habitat within San Francisquito Creek for all three of these species. In addition, there are CNDDDB records of these species within five miles of the Study Area. Ruderal habitat and landscaped areas in the Study Area also provide potential suitable nesting habitat for white-tailed kite, as well as birds protected under the Migratory Bird Treaty Act (MBTA) and California Fish and Game Code (CFGC).

The Proposed Project has potential to result in direct impacts to two special status reptiles (San Francisco garter snake and Western pond turtle) and two special status amphibians (California red-legged frog and California tiger salamander). Avoidance, minimization, and mitigation measures are recommended in **Appendix C** to reduce potential impacts to special status animals to less than significant. **Mitigation Measure BIO-1** will be implemented to require pre-construction surveys for these species, fencing and other protective measures if found present, and capture and relocation, as applicable. All of these measures will ensure that potential impacts to special status animal species are reduced to less than significant.

Mitigation Measure BIO-1: Protection of Special Status Animals

The following avoidance, minimization, and mitigation measures are recommended to reduce potential impacts to special status animals.

California Red-legged Frog (CRLF) and California Tiger Salamander (CTS)

- Prior to start of project activities, a qualified biologist shall prepare and administer a Worker Environmental Awareness Program (WEAP) training to familiarize all personnel conducting project activities with the identification and life-history of CRLF and CTS.
- If feasible, initial ground disturbing activities and any work associated with the project shall be conducted between May 1 and October 31 during dry weather conditions to minimize the potential for encountering CRLF and CTS. Work shall be restricted to daylight hours.
- A qualified biologist shall conduct a survey of the project area within 48 hours prior to initial ground disturbing activities. The survey area shall include all potential suitable upland habitat in the project area and suitable aquatic and upland habitat located within 50 feet of the project area. The survey shall also include identifying all mammal burrows in the project area that are suitable for CRLF and CTS. If any life stage of CRLF or CTS is found within the survey area, the biologist shall revisit the site on subsequent days to determine if the CRLF or CTS has left the site. If the CRLF or CTS has not left the site after three days, the USFWS (for CRLF and CTS) and CDFW (for CTS) shall be consulted to determine the appropriate course of action.
- All work areas within 25 feet of suitable aquatic habitat shall be flagged for monitoring during construction activity.
- If construction must occur between November 1 and April 30, the qualified biologist shall conduct a pre-activity clearance sweep prior to start of project activities within 48 hours after any rain events of 0.1 inch or greater or if wet conditions are present on site.
- All trash shall be removed from the site daily and disposed of properly to avoid attracting potential predators to the site.

- No pets shall be permitted on-site during project activities.
- All vehicles shall be in good working condition and free of leaks. All leaks shall be contained and cleaned up immediately to reduce the potential for soil/vegetation contamination.
- All refueling, maintenance, and staging of equipment and vehicles shall occur at least 100 feet from riparian habitat or water bodies and in a location from where a spill would not drain directly toward aquatic habitat (e.g., on a slope that drains away from the water).
- The number of access routes, size of staging areas, and the total area of the activity shall be limited to the minimum necessary to achieve the project goals.
- To ensure that diseases are not conveyed between work sites by the qualified biologist, the fieldwork code of practice developed by the Declining Amphibian Populations Task Force shall be followed at all times.
- No herbicide shall be used on-site.
- A qualified biologist shall be present on site during initial ground disturbance in portions of the project area that are suitable upland habitat for CRLF or CTS or within 25 feet of potential CRLF or CTS aquatic habitat. If any life stage of CRLF or CTS is found, work shall cease within 100 feet of the CRLF or CTS and the USFWS and CDFW contacted immediately to determine the appropriate course of action.

San Francisco Garter Snake

- Prior to start of project activities, a qualified biologist shall conduct a WEAP training to familiarize all personnel conducting project activities with the identification and life history of SFGS.
- A qualified biologist shall conduct a survey within 48 hours of initial ground disturbing activities. The survey area shall include all potential suitable upland habitat in the project area and suitable aquatic and upland habitat located within a 100 feet of the project area. The survey shall also include identifying all mammal burrows in the project area that are suitable for SFGS. If any life stage of SFGS is found within the survey area, the biologist shall revisit the site on subsequent days to determine if the SFGS has left the site. If the SFGS has not left the site after three days, the USFWS shall be consulted to determine the appropriate course of action.
- A qualified biologist shall be present on site during initial ground disturbance in portions of the project area that are within 25 feet of potential SFGS aquatic habitat.
- If a SFGS is encountered, all activities within 100 feet of the snake shall cease until appropriate corrective measures have been completed or it has been determined that the snake will not be harmed. Reports of any SFGS sightings and any project-related incidental take shall be reported to the USFWS immediately by telephone at (916) 414-6600.

Western Pond Turtle (WPT)

- Prior to start of project activities, a qualified biologist shall conduct a WEAP training to familiarize all personnel conducting project activities with the identification and life history of WPT.
- A pre-construction survey for WPT shall be conducted in the project area, plus a 50-foot buffer, not less than two weeks prior to the initiation of construction. The survey shall include San Francisco Creek and the golf course pond adjacent to the project area.

- If WPT is found and these individuals are likely to be killed or injured by construction activities, a qualified biologist shall be allowed sufficient time to capture and relocate the animals from the project site before construction activities begin. A qualified biologist(s) shall relocate the individuals the shortest distance possible to a location that contains suitable habitat not likely to be affected by activities associated with the proposed project. The biologist(s) shall maintain sufficiently detailed records of any individual observed, captured, relocated, etc., including size, coloration, any distinguishing features and photographs (preferably digital) to assist him or her in determining whether translocated animals are returning to the project site.

Additionally, the Proposed Project has potential to result in direct impacts to nesting birds, including raptors such as white-tailed kite, and other species protected under the MBTA and/or CFGC. Birds nesting on or adjacent to the project site during construction activities may be killed or injured by crushing or tree/shrub removal (direct impact) or may abandon active nests as a result of construction activity and/or noise (indirect impact). Avoidance, minimization, and mitigation measures are recommended in **Appendix C** to reduce potential impacts to nesting birds to less than significant. **Mitigation Measure BIO-2** will be implemented to require pre-construction surveys for these species (if construction occurs during bird breeding season; February 1 through August 31), fencing and other protective measures if found present, and monitoring of active nests. All of these measures will ensure that potential impacts to nesting birds are reduced to less than significant.

Mitigation Measure BIO-2: Protection of Nesting Birds

The following avoidance, minimization, and mitigation measures are recommended to reduce potential impacts to nesting birds.

- Nesting bird surveys are not required for construction activities that occur between September 1 and January 31. If construction must occur within the bird breeding season (February 1 through August 31), then no more than two weeks prior to initiation of ground disturbance and/or vegetation removal, a nesting bird and raptor preconstruction survey shall be conducted by a qualified biologist within the disturbance footprint plus a 300-foot buffer, where feasible. If the project is phased, a subsequent pre-construction nesting bird and raptor survey shall be required prior to each phase of construction within the project site.
- Pre-construction nesting bird and raptor surveys shall be conducted during the time of day when birds are active and shall be of sufficient duration to reliably conclude presence/absence of nesting birds and raptors onsite and within the designated vicinity. A report of the nesting bird and raptor survey results, if applicable, shall be submitted to the lead agency for review and approval prior to land use clearance for grading.
- If nests are found, their locations shall be flagged. An appropriate avoidance buffer ranging in size from 25 to 50 feet for song birds, and up to 250 feet for raptors depending upon the species and the proposed work activity shall be determined and demarcated by a qualified biologist with bright orange construction fencing or other suitable flagging. Active nests shall be monitored at a minimum of once per week until it has been determined that the nest is no longer being used by either the young or adults. No ground disturbance shall occur within this buffer until the qualified biologist confirms that the breeding/nesting is completed and all the young have fledged.

Implementation of Mitigation Measures BIO-1 and BIO-2 (as recommended in **Appendix C**) would reduce potential impacts to special status animals and birds to less than significant levels.

- b, c) There are no jurisdictional wetlands or waters of the United States in the Study Area. A concrete drainage in the valley oak stand adjacent to, but outside the WWTP footprint, is potentially considered a jurisdictional feature. It does not support any hydrophytic vegetation and the adjacent banks support upland vegetation. This channel collects runoff from Interstate 280 and directs it northwest outside the Study Area. This drainage channel could be considered a non-wetland water of the United States if it drains to a jurisdictional water. However, because it is located outside of the Study Area, impacts are considered less than significant.
- d) The influent pipeline and a majority of the distribution pipelines would be constructed within roadway ROWs, and are not expected to interfere with wildlife movement. The solids disposal pipeline would be constructed within SHG&CC property. The WWTP components would be sited along the southwest edge of the SHG&CC and would be constructed within previously disturbed and fenced open space. Menlo Park does not have any Priority Conservation Areas per the ABAG Priority Conservation Areas program (ABAG, 2015).

The Proposed Project is not located within any known regional wildlife movement corridors. The project site is situated on the western side of an extensively disturbed and developed area along the western side of the southern San Francisco Bay. To the west of the project site is a mix of residential developments and open Coast Range woodland and grassland areas. Wildlife movement to the east of the project area has long been disrupted. Wildlife movement to the west would be expected to be generally directed in a north-south orientation along existing areas of undeveloped woodland and grassland areas. San Francisquito Creek may function as a small local movement corridor for wildlife between the Coast Range and the San Francisco Bay; however, the project will not directly impact this corridor, and project activity is not expected to disrupt wildlife movement along San Francisquito Creek. Given the disturbed nature of the site, the predominantly urban setting that the project area is situated within, and the placement of the proposed development within existing roadways and golf course areas, implementation of the Proposed Project is not expected to interfere with wildlife movement. Thus, impacts are considered less than significant.

- e) The City of Menlo Park Municipal Code (Municipal Code) Chapter 13.24 regulates the preservation of heritage trees (City of Menlo Park, 2010). Chapter 13.24 defines heritage trees as:
- A tree or group of trees of historical significance, special character or community benefit, specifically designated by resolution of the City Council;
 - An oak tree (*Quercus* spp.) which is native to California and has a trunk with a circumference of 31.4 inches (diameter of ten [10] inches) or more, measured at fifty-four (54) inches above natural grade. Trees with more than one trunk shall be measured at the point where the trunks divide, with the exception of trees that are under twelve (12) feet in height, which will be exempt from this section; and
 - All trees other than oaks which have a trunk with a circumference of 47.1 inches (diameter of fifteen (15) inches) or more, measured fifty-four (54) inches above natural grade. Trees with more than one trunk shall be measured at the point where the trunks divide, with the exception of trees that are less than twelve (12) feet in height, which will be exempt from this section. (Ord. 928 Section 1 (part), 2004).

In accordance with the City of Menlo Park's Municipal Code, the removal of protected trees or pruning more than one fourth of its canopy and/or roots requires a permit. Prior to construction activities, a site plan should be prepared depicting the locations of trees in the project area. A tree protection plan is required for any work performed within an area 10 times the diameter of the tree (the tree protection zone). The removal of two or more protected trees also requires the

submission of a tree replacement plan. Commercial applicants are required to replace trees on a 2 to 1 basis with at least a #15 container size.

The proposed project has the potential to result in impacts to protected trees. Two mature valley oak trees are within the footprint of the WWTP and other protected trees are potentially located adjacent to other portions of the project area. These trees will not be removed during the construction of the WWTP. However, trenching, soil compaction, grade changes, and the installation of pavement within the tree protection zone of these valley oak trees is likely to impact the roots of these trees. Other portions of the project area are adjacent to protected trees, including coast redwood that could potentially be impacted by the Proposed Project. The tree protection plan required by the City of Menlo Park Municipal Code – per Mitigation Measure BIO-3 – will ensure that necessary protective measures are taken for these trees. **Mitigation Measure BIO-3** will be require pre-construction assessment for protected trees, preparation of a tree preservation plan, and tree removal permitting and replacement plan, if applicable. All of these measures will ensure that potential impacts to protected trees are reduced to less than significant.

Mitigation Measure BIO-3: Preservation of Protected Trees

The following avoidance, minimization, and mitigation measures are recommended to reduce potential impacts to protected trees.

- Prior to the construction, an arborist or botanist shall assess potential impacts to protected trees within and adjacent to the project area, including staging areas and access routes and prepare a tree preservation plan. When feasible, the project footprint shall be modified to avoid the critical root zone (CRZ) and tree protection zone (TPZ) of protected trees. Prior to the commencement of construction activities, the TPZ of protected trees shall be identified in the field by an arborist or botanist and clearly delineated with temporary orange fencing. Construction activities and equipment shall be excluded from the TPZ.
- During construction, if activities encroach on the TPZ of a protected tree, an arborist or botanist shall be consulted about whether or not the tree is likely to be impacted and whether a tree removal permit and tree replacement plan is required. Tree replacement shall be in accordance with the relevant City of Menlo Park ordinances.

Implementation of Mitigation Measure BIO-3 (as recommended in **Appendix C**) would reduce potential impacts to protected trees to less than significant levels.

- f) The Proposed Project would not be sited in any of the areas designated by the Midpeninsula Regional Open Space District as Priority Conservation Areas (ABAG, 2015).

3.5 Cultural Resources

	<u>Potentially Significant Impact</u>	<u>Less Than Significant With Mitigation Incorporation</u>	<u>Less Than Significant Impact</u>	<u>No Impact</u>
Would the Project:				
a) Cause a substantial adverse change in the significance of a historical resource as defined in §15064.5?	<input type="checkbox"/>	<input checked="" type="checkbox"/>	<input type="checkbox"/>	<input type="checkbox"/>
b) Cause a substantial adverse change in the significance of a unique archaeological resource pursuant to §15064.5?	<input type="checkbox"/>	<input checked="" type="checkbox"/>	<input type="checkbox"/>	<input type="checkbox"/>
c) Directly or indirectly destroy a unique paleontological resource or site or unique geologic feature?	<input type="checkbox"/>	<input checked="" type="checkbox"/>	<input type="checkbox"/>	<input type="checkbox"/>
d) Disturb any human remains, including those interred outside of formal cemeteries?	<input type="checkbox"/>	<input checked="" type="checkbox"/>	<input type="checkbox"/>	<input type="checkbox"/>

Discussion

a-b) **Appendix D** contains a Cultural Resources Assessment of the Proposed Project area of potential effect (APE). The APE lies in the San Francisco Bay Area archaeological region (Milliken et al. 2007; Moratto 1984), within an area traditionally occupied by the Ohlone (or Costanoan) people. Ohlone territory extends from the point where the San Joaquin and Sacramento Rivers issue into the San Francisco Bay to Point Sur, with the inland boundary most likely constituted by the interior Coast Ranges (Kroeber 1925:462). A search of the cultural resource records housed at the California Historical Resources Information System (CHRIS), Northwest Information Center (NWIC) did not reveal any historic addresses near the project APE. Three previously recorded archaeological resources were identified adjacent to the current project APE as a result of the records search and Native American scoping. One of these resources (P-41-000259/P-43-002239) is recorded directly adjacent to the eastern extension of the project APE and is presumed eligible under the California Register of Historical Resource (CRHR). This site was excavated from 1987 to 2004 by Ohlone Family Consulting Services in cooperation with Stanford University. The excavations took place to recover burial deposits and associated artifacts identified during construction activities for the widening of Sand Hill Road. One burial associated with the site was found along the western margin of Sand Hill Road approximately 10 feet east of the eastern extent of the APE.

A cultural resources survey of the Proposed Project APE was conducted on April 20, 2015. No cultural resources were identified within the project site during this study. Therefore, no impacts to historical resources under CEQA and no effects to historic properties under the NHPA for the Proposed Project are expected. However, based on the high level of prehistoric sites located adjacent to and surrounding the project APE, the APE is sensitive for buried archaeological resources. Previous construction activities associated with the expansion of Sand Hill Road, adjacent hospital construction, and golf course construction yielded numerous cultural resources including human burials associated with resource P-41-000259/P-43-002239.

Bocek and Rutherford (1987) suggest that the extension of P-41-000259/P-43-002239 beneath Sand Hill Road was destroyed during construction, but this cannot be confirmed given the existing condition of the APE (capped by existing roads and structures). Additionally, the area in and around the APE has been disturbed by previous construction activities including housing and infrastructure (e.g., roads and sewage pipelines). Nevertheless, the area remains sensitive for cultural resources. Based on this sensitivity, archaeological and Native American monitoring for all ground-disturbance activities, as described in **Mitigation Measure CUL-1** and **CUL-2**, would be implemented to mitigate any potential impacts to less than significant.

Consultation with Native American tribes in the Proposed Project vicinity was conducted on June 10, 2015, as outlined in **Appendix D** (see Table 3: Coordination with Local Native American Groups). Two Chairpersons recommended that an archeological and Native American monitor be present for all ground disturbing activities, and another requested notification of new discoveries made during Project construction. None of the Native American tribes that were contacted for the Proposed Project requested government-to-government consultation per Assembly Bill 52. **Mitigation Measure CUL-1** requires archaeological and Native American monitoring during Project construction.

Mitigation Measure CUL-1: Archaeological and Native American Monitoring

Archaeological and Native American monitoring of all project-related ground-disturbing activities shall be performed under the direction of an archaeologist meeting the Secretary of the Interior's Professional Qualifications Standards for archaeology.

Mitigation Measure CUL-2: Archaeological Resource Finds

If archaeological resources are encountered during ground-disturbing activities, all earth disturbing work within the vicinity of the find shall be temporarily suspended or redirected until an archaeologist has evaluated the nature and significance of the find. Evaluation of significance for the find may include the determination of whether or not the find qualifies as an archaeological site. Isolated finds typically do not qualify as historical resources under CEQA or historic properties under the National Historic Preservation Act (NHPA) and require no management consideration under either regulation. Should any resource(s) be identified, an evaluation of eligibility for the CRHR and NRHP may be required through the development of a treatment plan including a research design and subsurface testing through the excavation of test units and shovel test pits. After effects to the find have been appropriately mitigated, work in the area may resume. Mitigation of effects to the find may include a damage assessment of the find, archival research, and/or data recovery to remove any identified archaeological deposits, as determined by a qualified archaeologist.

If an inadvertent archaeological or burial discovery is made within State right-of-way, all construction-related activities within 50 feet of the find shall cease and Caltrans Office of Cultural Resource Studies (OCRS), District 4 shall be immediately contacted. A staff archaeologist shall then evaluate the significance of the find within one business day of initial contact.

Implementation of Mitigation Measures CUL-1 and CUL-2 (as recommended in **Appendix D**) would reduce potential impacts to archeological resources to less than significant levels.

- c) A paleontological resource assessment was performed and consisted of a fossil locality record search, review of existing geologic maps, site survey, and a review of primary literature regarding fossiliferous geologic units within the project vicinity and region. The project area contains two mapped units that have a high paleontological sensitivity, and could yield scientifically significant paleontological resources; Pleistocene stream terraces (Qst) and Ladera Sandstone (Tl). Ladera Sandstone deposits occur extensively within the western portion of the project area

and along Sand Hill Road and thus represent a high potential for ground-disturbing construction activity to impact scientifically significant paleontological resources. In addition, Pleistocene alluvium occurs within the eastern portion of the project site and in pockets along Sand Hill Road. Pleistocene alluvium has a record of abundant and diverse vertebrate fauna throughout California (Agenbrood 2003; Macias et al. 2014; Springer et al. 2009) and is generally considered to have high paleontological sensitivity wherever it occurs.

The proposed project is likely to impact geologic units with high paleontological sensitivity, both at the surface and at depth. As such, and because of the high paleontological sensitivity of two mapped units within the project area, development of a Paleontological Mitigation Plan (PMP) is recommended to mitigate for potential impacts. The PMP should be specifically crafted to the fossilbearing units known to exist within the project area. **Mitigation Measure CUL-3** will be implemented to prepare and implement a PMP.

Mitigation Measure CUL-3: Develop and Implement Paleontological Mitigation Plan

WBSD shall develop and implement a Paleontological Mitigation Plan (PMP) following final design. The PMP should include the following components:

- The PMP should be prepared by a qualified principal paleontologist (M.S. or Ph.D. in paleontology) once adequate project design information regarding subsurface disturbance location, depth and lateral extent is available.
- The qualified principal paleontologist should be present at pre-construction meetings to confer with contractors who will be performing ground disturbing activities.
- Paleontological monitors, under the direction of the qualified principal paleontologist, should be on site to inspect cuts for fossils at all times during original ground disturbance involving sensitive geologic formations.
- When fossils are discovered, the paleontologist (or paleontological monitor) should recover them. Construction work in these areas may be halted by the Resident Engineer or diverted to allow the prompt recovery of fossils.
- Fossils collected during the monitoring and salvage portion of the mitigation program should be prepared to the point of identification, sorted, and cataloged.
- Prepared fossils, along with copies of all pertinent field notes, photos, and maps, should be deposited in a scientific institution with paleontological collections.
- A Paleontological Mitigation Report should be completed that outlines the results of the mitigation program.
- Where feasible, selected road cuts or large finished slopes in areas with critically interesting paleontological features may be left exposed so they can serve as important educational and scientific features. This may be possible if no substantial adverse visual or safety impacts result.

Implementation of **Mitigation Measure CUL-3** (as recommended in **Appendix D**) would reduce potential impacts to paleontological resources to less than significant levels.

- d) The discovery of human remains is always a possibility during ground disturbing activities. If human remains are found, the State of California Health and Safety Code §7050.5 states that no further disturbance shall occur until the county coroner has made a determination of origin and disposition pursuant to Public Resources Code §5097.98. In the event of an unanticipated discovery of human remains, the San Mateo County coroner must be notified immediately. If the human remains are determined to be prehistoric, the coroner will notify the Native American

Heritage Commission (NAHC), which will determine and notify a most likely descendant (MLD). The MLD shall complete the inspection of the site within 48 hours of notification and may recommend scientific removal and nondestructive analysis of human remains and items associated with Native American burials. Compliance with applicable State codes in the event of discovery of human remains will reduce potential impacts to less than significant levels.

3.6 Geology and Soils

<i>Potentially Significant Impact</i>	<i>Less Than Significant With Mitigation Incorporation</i>	<i>Less Than Significant Impact</i>	<i>No Impact</i>
---	--	---	----------------------

Would the Project:

a) Expose people or structures to potential substantial adverse effects, including the risk of loss, injury, or death involving:				
i) Rupture of a known earthquake fault, as delineated on the most recent Alquist-Priolo Earthquake Fault Zoning Map issued by the State Geologist for the area or based on other substantial evidence of a known fault? Refer to Division of Mines and Geology Special Publication 42.	<input type="checkbox"/>	<input type="checkbox"/>	<input checked="" type="checkbox"/>	<input type="checkbox"/>
ii) Strong seismic ground shaking?	<input type="checkbox"/>	<input type="checkbox"/>	<input checked="" type="checkbox"/>	<input type="checkbox"/>
iii) Seismic-related ground failure, including liquefaction?	<input type="checkbox"/>	<input type="checkbox"/>	<input checked="" type="checkbox"/>	<input type="checkbox"/>
iv) Landslides?	<input type="checkbox"/>	<input type="checkbox"/>	<input checked="" type="checkbox"/>	<input type="checkbox"/>
b) Result in substantial soil erosion or the loss of topsoil?	<input type="checkbox"/>	<input type="checkbox"/>	<input checked="" type="checkbox"/>	<input type="checkbox"/>
c) Be located on geologic unit or soil that is unstable, or that would become unstable as a result of the Project, and potentially result in on-or off-site landslide, lateral spreading, subsidence, liquefaction, or collapse?	<input type="checkbox"/>	<input type="checkbox"/>	<input checked="" type="checkbox"/>	<input type="checkbox"/>
d) Be located on expansive soil, as defined in Table 18-1-B of the Uniform Building Code (1994), creating substantial risks to life or property?	<input type="checkbox"/>	<input type="checkbox"/>	<input checked="" type="checkbox"/>	<input type="checkbox"/>
e) Have soils incapable of adequately supporting the use of septic tanks or alternative wastewater disposal systems where sewers are not available for the disposal of wastewater?	<input type="checkbox"/>	<input type="checkbox"/>	<input type="checkbox"/>	<input checked="" type="checkbox"/>

Discussion

- a) The Study Area lies within the San Francisco Peninsula, a portion of the Coast Ranges Geomorphic Province. The San Francisco Peninsula is one of the world’s most seismically active regions, containing a series of sub-parallel earthquake faults and fault zones that generally trend in a northwest direction (City of Menlo Park, 2010). It is estimated that there is a 66% chance of a major earthquake (magnitude 6.0 or greater) in the Bay Area within the next 30 years (City of Menlo Park, 2010). There are six faults and fault systems in proximity to the Study Area, which are considered to be active. These faults include the San Andreas (2 miles west), Monte Vista-Shannon (3 miles southeast), Hayward (15 miles east), San Gregorio (12 miles southwest), and Calaveras (22 miles southeast) (See Figure 3.6-1) (CGS, 2010). All of the aforementioned faults and fault zones have potential to cause seismic ground shaking of at least “moderate” intensity (6.0 on the Modified Mercalli Intensity Scale (MMI)) due to their close proximity to the Study Area (ABAG, 2014). In addition, concealed Quaternary faults in proximity to the Study Area include the Palo Alto (5 miles northeast), San Jose (7 miles northeast), and Stanford (3 miles northeast) faults (CGS, 2010). However, these Quaternary faults do not show evidence of recent surface displacements (i.e., over the last 10,000 years) that would cause the California Geological Survey to classify them as active (CGS, 2010).

Figure 3.6-1. Active Fault Systems with potential to affect Study Area

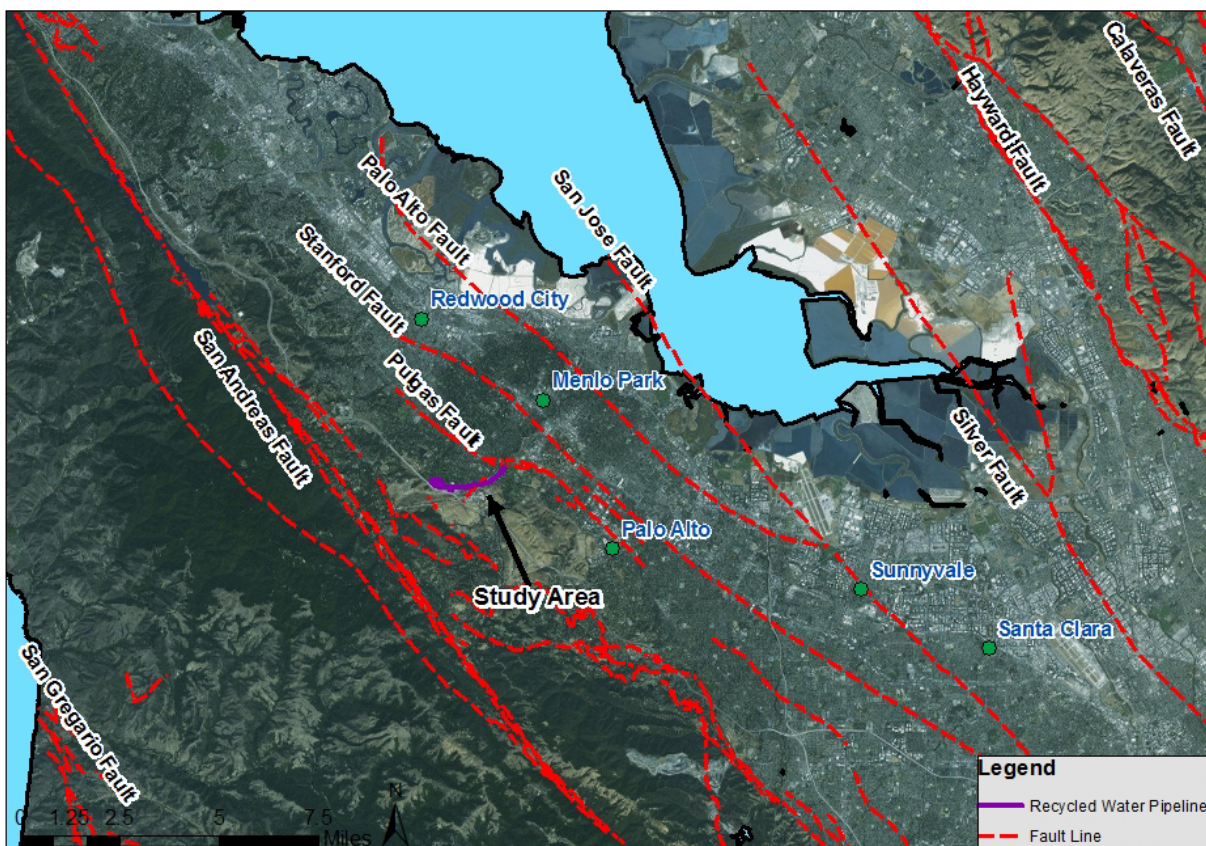

The Alquist-Priolo map for the region indicates that the Proposed Project site lies outside fault, and landslide zones (ABAG, 2014). None of the Proposed Project components would cross a known fault line or otherwise expose people or structures to ruptures of a known fault, so fault rupture is not considered a hazard.

While no fault lines cross the Study Area, it is vulnerable to seismic activity, especially strong seismic ground shaking, due to the presence of several active faults within the region. Major earthquakes on these regional faults could result in ground displacement and intense ground shaking that would be expected to damage vulnerable structures and could result in localized ground failure. The closest and most prominent active fault near the Study Area is the San Andreas Fault System, located about 2 miles west of the Study Area. However, there are four additional faults (Monte Vista-Shannon, San Gregorio, Hayward, and Calaveras) within a 20 mile radius of the Study Area which are expected to experience at least a ‘strong’ shaking effect (a magnitude of 6.0 and greater on the MMI Scale) in the Study Area if a rupture were to occur (USGS, 2013) (See Figure 3.6-2). However, if the San Gregario Fault were to rupture, the ABAG Shaking Hazard Maps shows the Study Area would be susceptible to ‘very strong’ shaking, a magnitude of 7.0 MMI and greater (ABAG, 2014) (See Figure 3.6-2). Due to the Proposed Project’s location with respect to these faults, it would be subject to design and construction regulations compliant with the 2013 California Building Code (CBC). This compliance would reduce the risks associated with seismic activities to less than significant levels.

**Figure 3.6-2. Shaking Hazard Map of the Study Area
(Estimated MMI within the Region, due to an Active Fault Line Rupturing)**

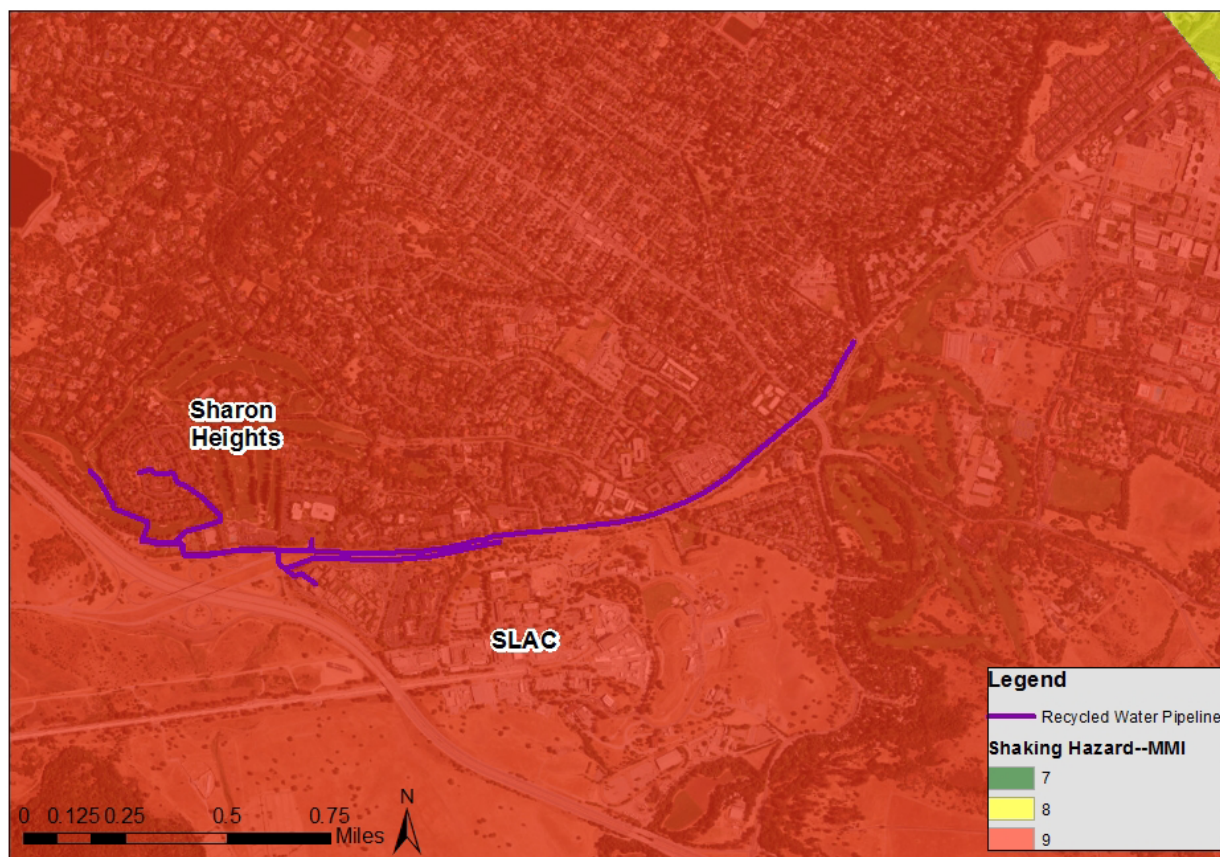

Liquefaction mapping shows that the majority of the Study Area, including the treatment site, solids waste discharge pipeline, and distribution pipeline, is located primarily within an area of low to very low liquefaction susceptibility (ABAG, 2014). The terminal end of the proposed influent wastewater forcemain is located within an area of moderate liquefaction susceptibility, and therefore could be impacted by seismically-induced settlement due to liquefaction (ABAG, 2015) (See Figure 3.6-3). Potential liquefaction hazard areas generally occur along Sand Hill Road at the eastern end of the Proposed Project. Therefore, design of all structures and facilities

associated with the Proposed Project would have to conform to building standards specified by the 2013 CBC and the International Building Code (IBC), which includes the former Uniform Building Code (UBC) and the Greenbook Standard Specifications for Public Works Construction. Compliance with applicable codes, regulations, and standards would reduce risks to the Proposed Project from liquefaction to less than significant.

Figure 3.6-3. Liquefaction Risk within Study Area

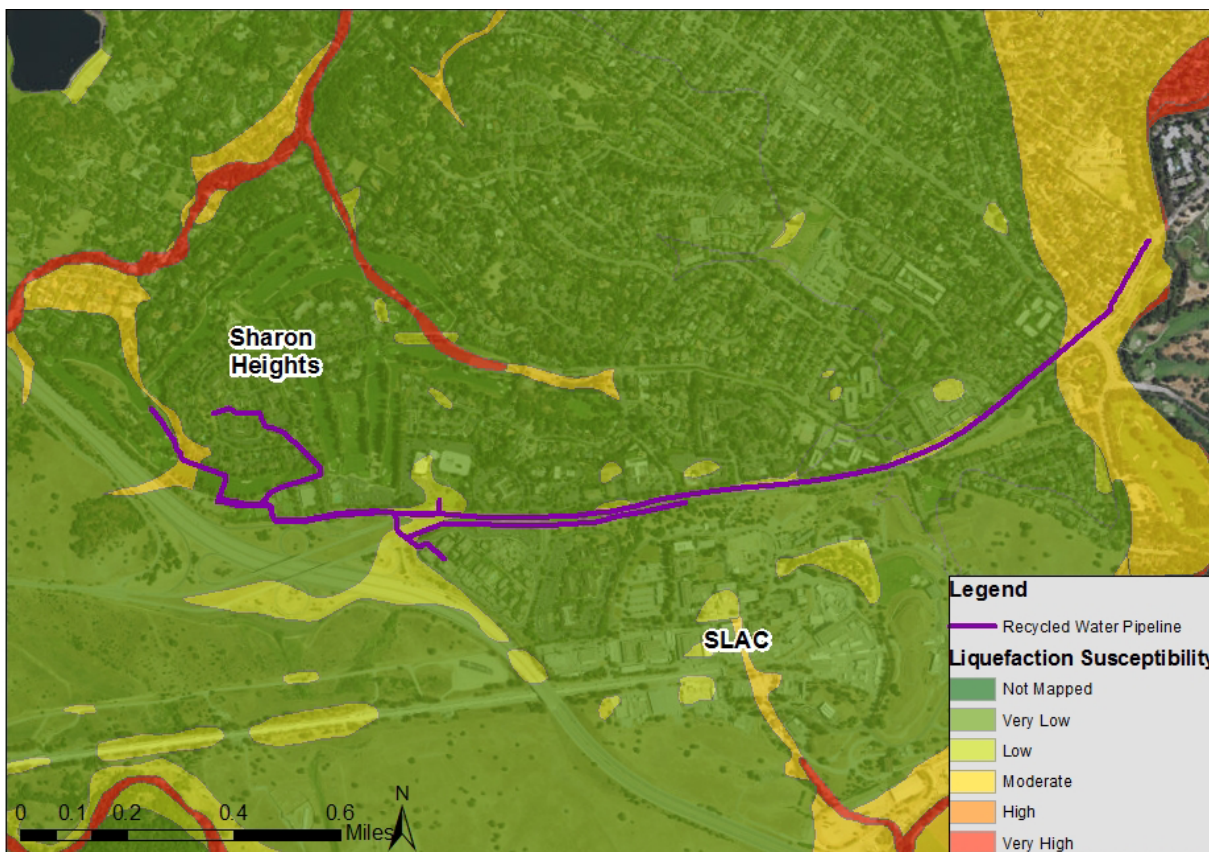

The Proposed Project is not located within an area delineated as an earthquake-induced landslide zone, nor is it located within a debris flow source area (CGS, 2015; ABAG, 2014). The solids disposal and influent pipelines would be constructed underground and in relatively flat areas. The risk of earthquake-induced landslides for the disposal and influent pipelines are therefore low and considered less than significant.

Proposed facilities are not habitable structures and would not expose residents to potential substantial adverse effects of seismic risks. The only people who may be exposed to seismic risks as a result of operation of the Proposed Project would be employees working at the WWTP. While seismic activity, mostly due to seismic ground shaking, poses a threat to the Study Area, compliance with the CBC, UBC, and other applicable building codes will ensure that geologic impacts are less than significant.

- b) Soil erosion is possible during construction, particularly due to grading activities at the treatment facility site. Implementation of typical Best Management Practices (BMPs) and the required SWPPP would reduce the potential risk for soil erosion or loss. Design of the WWTP may include retaining walls per design-level geotechnical investigations designed to minimize and/or prevent soil erosion or movement into the WWTP during project operation. Design criteria will

- be in compliance with the CBC, UBC, and other applicable building codes, which will ensure that soil erosion impacts are less than significant.
- c) The Study Area does not currently contain soils or slopes that are subject to landslides. The solids disposal pipeline would not affect the stability of the geologic unit or soil, or result in on- or off-site landslides, lateral spreading, subsidence, liquefaction, or collapse. However, grading and excavation required for the WWTP could create the potential for collapse or on-site landslide. Material excavated would be used to create screening berms and/or spread across other areas of the site to establish a preliminary grade for forming concrete slabs. Construction would include cut and fill, during which trenches would be backfilled to grade, although some backfill could result in steeper slopes than are currently present on the treatment facility site. If this occurs, WBSD will obtain a grading exemption from the County of San Mateo in accordance with the County of San Mateo’s Grading Ordinance. With compliance with all applicable codes and regulations, as well as receipt of applicable grading permits, potential impacts related to unstable geologic units or soils are considered less than significant.
 - d) While the Study Area does not currently contain soils potential to landslides, the majority of the Study Area and City of Menlo Park is underlain by clay loam soils, which have potential for expansion (NRCS, 2015). Expansive soils are typically very fine-grained with high percentages of clay minerals. A review of the U.S. Department of Agriculture (USDA) soil survey of the Study Area identified three major soil associations including: Accelerator-Fagan Association (including the Urban Land Complex), Orthents (cut and fill-Urban Land Complex), and Urban Land (NRCS, 2015). The Accelerator-Fagan association soils are comprised of deep, well drained loams and clay loams on 5 to 15% and considered an expansive soil (NRCS, 2015). Structures located on expansive soils would be designed such that they do not create substantial risks to life or property. Design criteria will be in compliance with the CBC, UBC, and other applicable building codes. Potential impacts caused by unstable soils would be reduced to less than significant levels through implementation of applicable building codes.
 - e) The Proposed Project includes wastewater treatment for non-potable reuse, but does not include septic-related waste. Sewers are available in the project vicinity for waste, including waste from the treatment processes. Therefore, there would be no significant impact related to septic tanks or alternative wastewater disposal methods.

3.7 Greenhouse Gas Emissions

<u>Potentially Significant Impact</u>	<i>Less Than Significant With Mitigation Incorporation</i>	<i>Less Than Significant Impact</i>	<i>No Impact</i>
---	--	---	----------------------

Would the Project:

- a) Generate greenhouse gas emissions, either directly or indirectly, that may have a significant impact on the environment?

<input type="checkbox"/>	<input type="checkbox"/>	<input checked="" type="checkbox"/>	<input type="checkbox"/>
--------------------------	--------------------------	-------------------------------------	--------------------------
- b) Conflict with an applicable plan, policy or regulation adopted for the purpose of reducing the emissions of greenhouse gases?

<input type="checkbox"/>	<input type="checkbox"/>	<input checked="" type="checkbox"/>	<input type="checkbox"/>
--------------------------	--------------------------	-------------------------------------	--------------------------

Discussion

- a, b) Air quality modeling has been conducted for the Proposed Project and estimates greenhouse gas (GHG) emissions of 667 MTCO₂eq/yr for construction and 195 MTCO₂eq/yr for operations. The BAAQMD identifies a threshold of significance for operational emissions of 1,100 MTCO₂eq/yr. While this threshold is not enacted, due to invalidation of BAAQMD’s CEQA process by the Alameda County Superior Court, the thresholds themselves were not called into question and are widely seen as defensible and appropriate, and have been widely applied. Operation of the WWTP (including chemical trip deliveries) and pump stations is expected to generate GHG emissions of 195 MTCO₂eq/yr, but due to the relatively small scale of the project, it does not exceed the BAAQMD threshold. As such, the Proposed Project would have a less than significant impact on GHG emissions. Further, due to the minimal nature of anticipated GHG emissions, the Proposed Project will not have a cumulatively considerable contribution to greenhouse gas accumulation.

3.8 Hazards and Hazardous Materials

Would the Project:	<u>Potentially Significant Impact</u>	<u>Less Than Significant With Mitigation Incorporation</u>	<u>Less Than Significant Impact</u>	<u>No Impact</u>
a) Create a significant hazard to the public or the environment through the routine transport, use, or disposal of hazardous materials?	<input type="checkbox"/>	<input checked="" type="checkbox"/>	<input type="checkbox"/>	<input type="checkbox"/>
b) Create a significant hazard to the public or the environment through reasonably foreseeable upset and accident conditions involving the release of hazardous materials into the environment?	<input type="checkbox"/>	<input checked="" type="checkbox"/>	<input type="checkbox"/>	<input type="checkbox"/>
c) Emit hazardous emissions or handle hazardous or acutely hazardous materials, substances, or waste within one-quarter mile of an existing or proposed school?	<input type="checkbox"/>	<input checked="" type="checkbox"/>	<input type="checkbox"/>	<input type="checkbox"/>
d) Be located on a site which is included on a list of hazardous materials sites compiled pursuant to Government Code Section 65962.5 and, as a result, would it create a significant hazard to the public or the environment?	<input type="checkbox"/>	<input type="checkbox"/>	<input checked="" type="checkbox"/>	<input type="checkbox"/>
e) For a project located within an airport land use plan or, where such a plan has not been adopted, within two miles of a public airport or public use airport, would the project result in a safety hazard for people residing or working in the project area?	<input type="checkbox"/>	<input type="checkbox"/>	<input type="checkbox"/>	<input checked="" type="checkbox"/>
f) For a project within the vicinity of a private airstrip, would the project result in a safety hazard for people residing or working in the Project area?	<input type="checkbox"/>	<input type="checkbox"/>	<input type="checkbox"/>	<input checked="" type="checkbox"/>

- g) Impair implementation of or physically interfere with an adopted emergency response plan or emergency evacuation plan?
- h) Expose people or structures to a significant risk of loss, injury or death involving wildland fires, including where wildlands are adjacent to urbanized areas or where residences are intermixed with wildlands?

Discussion

a,b,c) Construction would not require the long-term routine transport, use, or disposal of hazardous materials. However, hazardous materials and substances such as diesel fuel would be transported to, handled, and used at the construction sites and could present a hazard to the public or the environment through their accidental release. One school – the Trinity School (preschool and elementary) – is located within one-quarter mile of the proposed work sites. In addition, construction could encounter hazardous materials that could pose a threat to workers, the public, or the environment. Because of the possibility of accidental release, the proximity to schools and other sensitive receptors, potential impacts would be considered significant. However, with **Mitigation Measure HAZ-1** requiring a Hazardous Materials Management and Spill Prevention Plan and Control Plan, the risk of hazardous materials release is low and potential impacts would be reduced to less than significant.

Mitigation Measure HAZ-1: Hazardous Materials Management and Spill Prevention and Control Plan

Before construction begins, WBSD shall require its construction contractor to prepare a Hazardous Materials Management Spill Prevention and Control Plan that includes a project-specific contingency plan for hazardous materials and waste operations. The Plan shall be applicable to construction activities, and shall establish policies and procedures according to applicable codes and regulations, including but not limited to the California Building and Fire Codes, and federal and California Occupational Safety and Health Administration (OSHA) regulations. Elements of the Plan shall include, but not be limited to the following:

- A discussion of hazardous materials management, including delineation of hazardous material storage areas, access and egress routes, waterways, emergency assembly areas, and temporary hazardous waste storage areas;
- Notification and documentation of procedures; and
- Spill control and countermeasures, including employee spill prevention/response training.

Operation of the WWTP would require the long-term routine transport and use of hazardous materials and substances for treatment, cleaning, and other operation and maintenance purposes. Chemicals that would be transported to and/or from, and used at, the proposed treatment facility may include lubrication oils, grease, sodium hypochlorite, caustic soda, and citric acid. All of the chemical facilities would be stored in double containment to ensure protection in the event of an accidental spill, and the depth of the tanks relative to the surrounding terrain would afford extra protection in the event of an accidental spill. The chemicals listed above would be transported by truck to the treatment facility. The Proposed Project would result in chemical delivery truck trips of 24 trips per year.

The City currently has a permit process for the use of hazardous materials. The Menlo Park Fire Protection District has established threshold levels based on the California Fire Code to define the maximum amount of hazardous materials that would be allowed before a use permit is required.

The City also has adopted an Emergency Operation Plan that assesses the potential losses associated with inadvertent or intentional releases of hazardous materials that could affect the public and identifies responsibilities for city departments and coordination with San Mateo County and regional emergency response providers.

Because Trinity School and some residences are within one-quarter mile of the WWTP, impacts associated with the accidental release of hazardous materials are considered potentially significant. However, with **Mitigation Measure HAZ-1** requiring a Hazardous Materials Management and Spill Prevention Plan and Control Plan and compliance with the City's Emergency Operation Plan, the risk of hazardous materials release during construction or operation is low and potential impacts would be reduced to less than significant.

- d) Hazardous Materials currently used in the Study Area may include household hazardous materials common to residential areas, as well as other regulated hazardous materials common in the urbanized industrial areas. **Appendix E** contains a search of available environmental records for the Study Area, including records from the State Water Resources Control Board SWRCB GeoTracker database and the California Department of Toxic Substances Control (DTSC) EnviroStor database. These lists are a compilation of information from various sources listing potential and confirmed hazardous waste and hazardous substances sites in California. Within the Study Area, there are no properties that are included on a list of hazardous material sites compiled pursuant to Government Code Section 65962.5 ("Cortese List"). All properties of potential concern have been completed and closed including: a leaking underground storage tank (LUST) cleanup site on SHG&CC (closed in 1991), a hazardous waste cleanup at Stanford University (closed in 1998), and two Shell gasoline groundwater cleanup sites (closed in 2000 and 2009) (CWSRCB, 2015). The terminal end of the pipe alignment along Sand Hill Road is within a 1,100 foot radius of an Open Cleanup Site at Sharon Heights Cleaners, which has been underway since 2006 (CWSRCB, 2015). Given the lack of relevant hazardous materials cleanup sites within the Study Area, this impact is considered less than significant.
- e, f) The Study Area does not include any airports. The nearest airport to the Study Area is in the City of Palo Alto, six miles northeast of the Proposed Project. As such, the Proposed Project would not expose people residing or working in the area to safety hazards.
- g) Construction activities for the proposed influent, solids disposal, and recycled water distribution pipelines may require temporary lane or road closures that could impede emergency responses. Specifically, lane closures along Sand Hill Road would disrupt traffic on a major arterial. The Traffic Management Plan required in **Mitigation Measure TRA-1** (see below) would address any potential interference with emergency response and/or evacuation plans, and would reduce these impacts to less than significant.
- h) According to the California Department of Forestry and Fire Protection's Fire Hazard Severity Zone (FHSZ) and ABAG Fire Hazard maps, the Proposed Project is located within a moderate to high FHSZ (ABAG, 2014). The Proposed Project portions lies within a "Fire Threatened" Community (ABAG, 2014). Use of spark producing construction machinery within or adjacent to areas of Moderate or High Fire Hazard could potentially create hazardous fire conditions and expose people to wildlife risks. As such, the Proposed Project has the potential to generate wildland fire-related hazards due to the location of project components in FHSZs. **Mitigation Measure HAZ-2** is needed to ensure that fire safety construction measures are employed during construction of the Proposed Project components that are within proximity to areas within or adjacent to Moderate and High FHSZs.

Mitigation Measure HAZ-2: Implement Fire Safety Construction Practices

WBSD shall require its construction contractor to implement fire safety construction practices, including but not limited to: clearing dried vegetation or other material that could ignite during construction from staging areas, welding areas, or other areas slated for construction. Construction equipment that includes a spark arrestor should be equipped in good working order. Additionally, construction crews should have a spotter during welding activities to look out for potentially dangerous situations, such as accidental sparks. Other construction equipment, including those with hot vehicle catalytic converters, should be kept in good working order and used only within cleared construction zones. Comply with the City of Menlo Park’s requirement to create and maintain approved fire access to work areas, in accordance with local fire regulations. During construction of the Proposed Project, the construction contractors shall require vehicles and crews working at the project site to have access to functional fire extinguishers.

With implementation of Mitigation Measure HAZ-2 requiring fire safety practices during construction, wildland fire impacts are considered less than significant.

3.9 Hydrology and Water Quality

	<i>Potentially Significant Impact</i>	<i>Less Than Significant With Mitigation Incorporation</i>	<i>Less Than Significant Impact</i>	<i>No Impact</i>
Would the Project:				
a) Violate any water quality standards or waste discharge requirements?	<input type="checkbox"/>	<input type="checkbox"/>	<input checked="" type="checkbox"/>	<input type="checkbox"/>
b) Substantially deplete groundwater supplies or interfere substantially with groundwater recharge such that there would be a net deficit in aquifer volume or a lowering of the local groundwater table level (e.g., the production rate of pre-existing nearby wells would drop to a level which would not support existing land uses or planned uses for which permits have been granted)?	<input type="checkbox"/>	<input type="checkbox"/>	<input type="checkbox"/>	<input checked="" type="checkbox"/>
c) Substantially alter the existing drainage pattern of the site or area, including through the alteration of the course of a stream or river, in a manner which would result in substantial erosion or siltation on- or off-site?	<input type="checkbox"/>	<input type="checkbox"/>	<input checked="" type="checkbox"/>	<input type="checkbox"/>
d) Substantially alter the existing drainage pattern of the site or area, including through the alteration of the course of a stream or river, or substantially increase the rate or amount of surface runoff in a manner which would result in flooding on- or off-site?	<input type="checkbox"/>	<input type="checkbox"/>	<input checked="" type="checkbox"/>	<input type="checkbox"/>
e) Create or contribute runoff water which would exceed the capacity of existing or planned storm	<input type="checkbox"/>	<input type="checkbox"/>	<input checked="" type="checkbox"/>	<input type="checkbox"/>

water drainage systems or provide substantial additional sources of polluted runoff?	<input type="checkbox"/>	<input type="checkbox"/>	<input checked="" type="checkbox"/>	<input type="checkbox"/>
f) Otherwise substantially degrade water quality?	<input type="checkbox"/>	<input type="checkbox"/>	<input checked="" type="checkbox"/>	<input type="checkbox"/>
g) Place housing within a 100-year flood hazard area as mapped on a federal Flood Hazard Boundary or Flood Insurance Rate Map or other flood hazard delineation map?	<input type="checkbox"/>	<input type="checkbox"/>	<input type="checkbox"/>	<input checked="" type="checkbox"/>
h) Place within a 100-year flood hazard area structures which would impede or redirect flood flows?	<input type="checkbox"/>	<input type="checkbox"/>	<input type="checkbox"/>	<input checked="" type="checkbox"/>
i) Expose people or structures to a significant risk of loss, injury or death involving flooding, including flooding as a result of the failure of a levee or dam?	<input type="checkbox"/>	<input type="checkbox"/>	<input type="checkbox"/>	<input checked="" type="checkbox"/>
j) Inundation of seiche, tsunami, or mudflow?	<input type="checkbox"/>	<input type="checkbox"/>	<input type="checkbox"/>	<input checked="" type="checkbox"/>

Discussion

a,f) Excavation, grading, and construction activities associated with construction of the Proposed Project could result in water quality violations from soil disturbance and potential sedimentation and erosion. It could also cause water quality violations in the event of an accidental fuel or hazardous materials leak or spill. If precautions are not taken to contain contaminants, construction could produce contaminated stormwater runoff (nonpoint source pollution), a major contributor to the degradation of surface water quality. Compliance with the Construction General Permit (General Permit for Discharges of Storm Water Associated with Construction Activity, Order 2009-0009-DWQ) requires the preparation and implementation of a formal Storm Water Pollution Prevention Plan (SWPPP) which must be prepared before construction begins. The SWPPP includes specifications for BMPs implemented during construction to control sedimentation or pollution concentration in stormwater runoff.

The San Francisco Bay Regional Water Quality Control Board (RWQCB) issued the Municipal Separate Storm Sewer (MS4) Phase I San Francisco Bay Region Municipal Regional Stormwater NPDES Permit No. CAS029718 (Order No. R2-2009-0074-DWQ) (San Francisco Bay MS4 Permit) on October 14, 2009. Under the MS4 provisions, all projects are responsible for implementing low impact development (LID) techniques to address stormwater runoff through source control, site design, and stormwater treatment measures. The WWTP site will be designed to result in no net runoff, in accordance with the MS4 requirements and WBSD’s standard construction practices.

Waste effluent would be conveyed by the WBSD sewer system for treatment and discharged via SVCW’s existing outfall, which has sufficient physical capacity for the anticipated level of discharge from the Proposed Project. The Proposed Project would increase the salinity of the discharge to the existing sewer line to SVCW, but not the quantity of discharge. Due to the small size of the project and small quantity of discharge relative to the total amount that SVCW currently treats, the addition of solids from the Proposed Project will not exceed SVCW’s NPDES permit limits. Compliance with SVCW’s NPDES Permit would ensure that San Francisco Bay water quality and associated beneficial uses are protected and operational water quality impacts mitigated to less than significant.

Recycled water created by the satellite WWTP will be initially used for application to turf on the SHG&CC and SLAC. The Proposed Project would be designed and operated in accordance with

the applicable requirements of California Code of Regulations (CCR) Title 22 and any other local legislation that is currently effective or may become effective as it pertains to recycled water. As proposed, the Project shall provide high quality recycled water to the golf course and SLAC. All landscape irrigation systems shall also be operated in accordance with the requirements of waste discharge requirements (WDRs) issued by the San Francisco RWQCB for WBSD's new recycled water system.

As described in the California Recycled Water Policy, salts and nutrients are a potential concern because recycled water could conceivably add measurable quantities of salts and/or nutrients to surface or groundwater supplies via incidental runoff, and cause a drinking water quality objective to be exceeded if assimilative capacity did not otherwise exist. The Proposed Project site does not overly a regional aquifer or groundwater basin, but localized aquifers may be present. Runoff or subsurface flows could also run into San Francisquito Creek, located to the northeast of the project. SWRCB finds the use of recycled water in accordance with Title 22 poses a less than significant impact on public health and safety. The Proposed Project would be required to comply with applicable standards that regulate the transport, use, storage, or disposal of hazardous materials as well as public health requirements that regulate tertiary-treated recycled water. Adherence to such regulations would ensure the Proposed Project would not create a significant water quality hazard or exceedance of established water quality standards.

A variety of factors contribute to the response of a landscape to recycled water, including the water quality of the irrigation water, soil characteristics (chemical characteristics, texture of the soil, soil profile, soil drainage, and soil structure), salt-tolerance of landscaped plants, and irrigation method and frequency. Recycled water is characteristically higher in alkaline salts than typical irrigation water derived from potable supplies and may cause declines in the health of low-salt tolerant tree species (e.g., redwood trees) under certain conditions. Additionally, salt buildup in poorly drained soil may create a long-term inability of the soil to absorb and provide water availability to the tree roots if proper site management practices are not implemented.

Researchers have studied crop/plant tolerance to salinity and other constituents, and have published water quality guidelines for many agricultural crops and landscape plants. The University of California has compiled this data and developed general guidelines for assessing the suitability of water for irrigation. These guidelines, summarized in Table 3.9-1, are general and flexible and are often modified based on local experience and special conditions of crop, soil, and method of irrigation.

For the Proposed Project, no adverse effects to turf would be anticipated based on the chloride and sodium levels in the planned recycled water, although turf used for golf greens can be more sensitive to water quality because the grass is stressed due to being cut very short. Sodium and chloride can also cause aesthetic (i.e., coloring) problems on the leaves of ornamental landscaping if spray irrigation is used. If these problems do occur, they can be mitigated with adjustments to the sprinklers of an irrigation system to avoid spray onto the foliage. WBSD will work with SHG&CC and SLAC to ensure that their watering practices accommodate for the water quality changes resulting from this new supply.

Table 3.9-1: Guidelines for Interpretation of Water Quality for Irrigation

Problem and Related Parameters	Units	Water Quality Guidelines		
		No Problem	Increasing Problems	Severe Problems
Salinity^a				
Electrical Conductivity	mmhos/cm	<0.75	0.75 – 3.0	>3.0
Total Dissolved Solids	mg/l	<480	480 – 1,920	>1,920
Permeability				
Adjusted SAR/Rnab	units	<6.0	6.0 – 9.0	>9.0
Specific ion toxicity from root absorption^c				
Adjusted SAR/RNa	units	<3.0	3.0 – 9.0	>9.0
Chloride	mg/l	<142	142 - 355	> 355
Boron	mg/l	<0.5	0.5 – 2.0	2.0 – 10.0
Foliar absorption – Sprinklers^d				
Sodium	mg/l	<69	>69	---
Chloride	mg/l	<106	>106	---
Miscellaneous				
HCO ₃ (Sprinklers)	mg/l	<90	90 - 520	>520
NH ₄ -N and NO ₃ -N	mg/l	<5	5 - 30	>30

Notes:

1. Source: Ayers, 1977.

Footnotes:

- a. Assumes water for crop plus needed water for leaching requirement will be applied.
- b. The adjusted SAR (adjusted sodium adsorption ratio) is calculated from an equation developed by U.S. Salinity Laboratory to include added effects of precipitation and dissolution of calcium in soils and related to carbonate/bicarbonate concentration. The adjusted SAR is defined as follows:
Adjusted SAR = $[Na/\sqrt{(Ca+Mg)/2}] * [1+(8.4 - pH_c)]$
Cation concentrations are expressed in meq/l and pH_c is calculated using tables that relate to the concentration values from the water analysis. Permeability problems, related to low EC or high adjusted SAR of water, can be reduced if necessary by adding gypsum. Usual application rate per acre-foot of applied water is from 200 to about 1,000 pounds. 234 pounds of 100% gypsum added to 1 acre-foot of water would supply 1 meq/l of calcium and raise the EC about 0.1 mmhos.
- c. Most tree crops and woody ornamentals are sensitive to sodium and chloride. Most annual crops are not sensitive.
- d. Leaf areas wet by sprinklers may show a leaf burn due to sodium or chloride absorption under low humidity/high-evaporation conditions.

Table 3.9-2 shows that early water quality testing for the Proposed Project’s tertiary effluent water quality indicates that the recycled water is expected to be of good quality and should have no impacts to plant life.

With compliance with the General Construction Permit, the San Francisco Bay MS4 Permit requirements, Title 22, the State’s Recycled water Policy, and the future WDRs, the Proposed Project will not degrade surface or groundwater quality from either construction or operation of the recycled water system.

Table 3.9-2: Landscape Irrigation Water Quality Comparison

Constituent	Units	Degree of Restriction on Use ¹			Sharon Heights Satellite ²
		None	Slight to Moderate	Severe	
Salinity					
TDS	mg/L	< 450	450 - 2,000	> 2,000	320
Specific Ion Toxicity					
Sodium (Na) ^{3,4}	mg/L	< 70	> 70		51
Chloride (Cl) ^{3,4}	mg/L	< 100	> 100		43
Boron (B)	mg/L	< 0.7	0.7 - 3.0	> 3.0	NA
Miscellaneous Effects					
pH	-	6.5 - 8.4			NA
Total Nitrogen ⁵	mg/L	< 5	5 – 30	> 30	66
Bicarbonate ⁷	mg/L	< 90	90 – 500	> 500	320

NA: Not available

1. Adapted from Metcalf and Eddy, 2007.
2. Alpine Road at Junipero Serra Boulevard
3. Values apply to most tree crops and woody ornamentals which are sensitive to sodium and chloride.
4. With overhead sprinkler irrigation and low humidity (< 30%), sodium or chloride levels greater than 70 or 100 mg/L, respectively, have resulted in excessive leaf adsorption and crop damage to sensitive crops.
5. Total nitrogen should include nitrate-nitrogen, ammonia-nitrogen, and organic-nitrogen. Although forms of nitrogen in wastewater vary, the irrigated plant responds to the total nitrogen.
6. Value of addition of Total Kjeldahl Nitrogen (17 mg/L), and combined nitrate-nitrite (3.7 mg/L) samples.
7. Overhead sprinkling only.

- b) The Proposed Project does not include groundwater pumping or recharge, and would have no impact to aquifer volumes or groundwater table levels. The project area and golf course are close to, but do not overly, an existing DWR Bulletin 118 groundwater basin. The San Mateo Plain Subbasin western boundary is about 3,000 feet northeast of Sharon Heights. No impacts to this basin are expected.
- c, d, e) The Proposed Project would not alter the course of a stream or river. The Proposed Project could temporarily alter the drainage of the Study Area during construction and excavation activities, which could result in additional sedimentation and erosion if mitigation measures are not incorporated to reduce these potential impacts. Additionally, installation of facilities at the treatment facility site could create additional runoff, sedimentation, and erosion during operation due to the grading needed at the site and the increased impermeable surface area. Installation of appropriate drainage (stormwater) facilities and erosion control at the site will be completed to manage stormwater flows and reduce the potential for localized siltation/erosion and flooding, per the San Francisco Bay MS4 Permit requirements. The inclusion of design elements to address runoff will ensure that impacts during operation of the Proposed Project would be less than significant.
- g) The Proposed Project would not construct housing; therefore it would have no impact related to placing housing within a 100-year flood zone.
- h) The National Flood Insurance Program branch of the Federal Emergency Management Agency (FEMA) maintains maps of floodways and floodplains for the United States. FEMA maps these

areas on Flood Insurance Rate Maps or FIRMs. A typical FIRM will show specific flood hazard areas, flood risk zones, and floodplains at a local level of detail. In some identified flood hazard zones, certain types of construction and/or uses are prohibited or are required to carry flood insurance. Cities and other jurisdictions use FIRMs to establish zoning districts, buffers, or other regulatory requirements intended to protect people and property from flood damage and minimize the cost of physical flood control mechanisms. The latest official flood data for the project site date from 2012. There are no special flood hazard areas in the Study Area (FIRM Panel: 06081C0312E). The Proposed Project is not located in and would not cross any flood zones. There would be no impact.

- i) The Proposed Project would not expose people to risks of flooding, dam, or levee failure. The treatment facility is the only component of the Proposed Project that would require staffing long-term, and is not located in a flood zone or downstream of an existing dam or levee. There would be no impact.
- j) There are no large enclosed water bodies in the Study Area that would be subject to seiche. Coastal low-lying areas in the City of Menlo Park may be affected by tsunamis, but the project area is over five miles away from the coast and at an elevation of over 200 feet above sea level and is not located within a tsunami evacuation area (City of Menlo Park, 2013; ABAG, 2014). There would be no impact.

3.10 Land Use and Planning

Would the Project:	<i>Potentially Significant Impact</i>	<i>Less Than Significant With Mitigation Incorporation</i>	<i>Less Than Significant Impact</i>	<i>No Impact</i>
a) Physically divide an established community?	<input type="checkbox"/>	<input type="checkbox"/>	<input type="checkbox"/>	<input checked="" type="checkbox"/>
b) Conflict with any applicable land use plan, policy, or regulation of an agency with jurisdiction over the Project (including, but not limited to the general plan, specific plan, local coastal program, or zoning ordinance) adopted for the purpose of avoiding or mitigating an environmental effect?	<input type="checkbox"/>	<input type="checkbox"/>	<input checked="" type="checkbox"/>	<input type="checkbox"/>
c) Conflict with any applicable HCP or NCCP?	<input type="checkbox"/>	<input type="checkbox"/>	<input type="checkbox"/>	<input checked="" type="checkbox"/>

Discussion

- a) The Proposed Project is located within roadway ROWs and within the property line of the SHG&CC. As the WWTP site is landlocked by other land uses and is under private ownership, development on this land would not divide the existing community. No impact would occur from the Proposed Project.
- b) The Proposed Project would be constructed in OSC zoning (for the WWTP) and roadway ROWs (pipelines). Pipeline installation is permitted within ROWs. Utility Substations can be located in any district with approval of a Conditional Use Permit (Menlo Park Municipal Code §16.76.030, prior code § 30.509(C) – “Public utility substations, pumping stations, equipment buildings and similar facilities may be located in any district, subject to obtaining a use permit, which shall be approved if it is found that the facility is necessary and designed in a manner compatible with the

neighborhood wherein it is proposed to be located.”) WBSD also has independent authority subject to the Sanitary District Act of 1923.²

Implementation of **Mitigation Measure AES-1**, above, would ensure that the proposed WWTP is designed and screened to be compatible with the surrounding neighborhood and structures. Implementation of **Mitigation Measure AES-1**, along with compliance with conditions contained in any Conditional Use Permit, would ensure that the Proposed Project does not conflict with any application land use plan, policy or regulation and impacts would be less than significant.

- c) The Study Area is not located within an adopted HCP/NCCP. There would be no impact.

3.11 Mineral Resources

Would the Project:	<i>Potentially Significant Impact</i>	<i>Less Than Significant With Mitigation Incorporation</i>	<i>Less Than Significant Impact</i>	<i>No Impact</i>
a) Result in the loss of availability of a known mineral resource that would be of value to the region and the residents of the state?	<input type="checkbox"/>	<input type="checkbox"/>	<input type="checkbox"/>	<input checked="" type="checkbox"/>
b) Result in the loss of availability of a locally-important mineral resource recovery site delineated on a local general plan, specific plan or other land use plan?	<input type="checkbox"/>	<input type="checkbox"/>	<input type="checkbox"/>	<input checked="" type="checkbox"/>

Discussion

- a, b) The Surface Mining and Reclamation Act (SMARA) of 1975 is the state legislation that protects mineral resource zones (MRZs) (CGS, 2015a). Part of the purpose of the act is to classify mineral resources in the state and to transmit the information to local governments which regulate land use in each region of the state. The law has resulted in the preparation of Mineral Land Classification Maps delineating MRZs 1 through 4 for aggregate resources (sand, gravel, and stone) (CGS, 2015a). There are no active mining or mineral resource extraction occurring within the Study Area. The closest quarry, the Permanent Quarry which is actively operated by the Lehigh Southwest Cement Company, is 10 miles south of the Study Area. The Permanente Quarry is a surface mining operation which excavates limestone and produces cement at an on-site cement factory (San Mateo County, 1986). However, the Proposed Project will have no impact on the operations of the Quarry. The Study Area is not delineated as a locally important mineral resource by the California Geological Survey or on any County of City land use plan. The Proposed Project would have no impact on the availability of known mineral resources of value to the region, state, or that are locally-important.

² The City of Menlo Park has stated that the proposed project would be appropriate in the OSC zoning district with a Conditional Use Permit. As a sanitary district organized and existing under the Sanitary District Act of 1923 (Cal. Health & Safety Code §6500, et seq.), WBSD also has independent authority to “acquire, plan, construct, reconstruct, alter, enlarge, law, renew, replace, maintain, and operate ... water recycling and distributions systems” within its jurisdictional boundaries.

3.12 Noise

Would the Project result in:	<u>Potentially Significant Impact</u>	<u>Less Than Significant With Mitigation Incorporation</u>	<u>Less Than Significant Impact</u>	<u>No Impact</u>
a) Exposure of persons to or generation of noise levels in excess of standards established in the local general plan or noise ordinance, or applicable standards of other agencies?	<input type="checkbox"/>	<input checked="" type="checkbox"/>	<input type="checkbox"/>	<input type="checkbox"/>
b) Exposure of persons to or generation of excessive groundborne vibration or groundborne noise levels?	<input type="checkbox"/>	<input checked="" type="checkbox"/>	<input type="checkbox"/>	<input type="checkbox"/>
c) A substantial permanent increase in ambient noise levels in the Project vicinity above levels existing without the Project?	<input type="checkbox"/>	<input checked="" type="checkbox"/>	<input type="checkbox"/>	<input type="checkbox"/>
d) A substantial temporary or periodic increase in ambient noise levels in the Project vicinity above levels existing without the Project?	<input type="checkbox"/>	<input checked="" type="checkbox"/>	<input type="checkbox"/>	<input type="checkbox"/>
e) For a project located within an airport land use plan or, where such a plan has not been adopted, within two miles of a public airport or public use airport, would the Project expose people residing or working in the project area to excessive noise levels?	<input type="checkbox"/>	<input type="checkbox"/>	<input type="checkbox"/>	<input checked="" type="checkbox"/>
f) For a project within the vicinity of a private airstrip, would the Project expose people residing or working in the Project area to excessive noise levels?	<input type="checkbox"/>	<input type="checkbox"/>	<input type="checkbox"/>	<input checked="" type="checkbox"/>

Discussion

a, c, d) Construction of the Proposed Project would involve the use of heavy equipment that could create noise substantially above existing ambient noise levels. Typical construction activities (e.g. jackhammering and use of earthmoving equipment) generate maximum noise levels (without noise controls) ranging from 75 to 90 dBA Lmax at 50 feet from the source, with slightly higher levels of about 81 to 96 dBA Lmax at 50 feet for pile-driving activities. The rate of attenuation (i.e., reduction) is about 6 dBA for every doubling of distance from a point source.

Construction noise has the potential to generate noise in excess of relevant local noise regulations. The City of Menlo Park’s Municipal Code §8.06.040 limits noise from powered equipment to 85 dBA at 50 feet. Implementation of **Mitigation Measure NOI-1** would require noise control practices to reduce noise impacts to less than significant levels.

Mitigation Measure NOI-1: Implement Noise Control Measures During Construction

To reduce noise during construction, WBSD shall require its construction contractor to comply with the City of Menlo Park's Municipal Code §8.06.040 and implement the following noise control measures:

- **Limit Construction Hours.** Construction hours shall be limited to times authorized under the City of Menlo Park's Municipal Code §8.06.040(a), 8:00am – 6:00pm on weekdays.
- **Locate Staging Areas away from Sensitive Receptors.** WBSD shall require the contractor to select staging areas as far as feasibly possible from sensitive receptors.
- **Idling Prohibition and Enforcement.** WBSD shall prohibit unnecessary idling of internal combustion engines. In practice, this would mean turning off equipment if it would not be used for five or more minutes.
- **Equipment Location, Mufflers, and Shielding.** WBSD shall require its contractors to locate stationary noise-generating construction equipment such as air compressors and generators as far as possible from homes and businesses. Mufflers and/or temporary noise barriers shall be used as necessary to meet the City's applicable sound level limits (unless a variance has been obtained in advance from the City). Temporary walls, stockpiles of excavated materials, or moveable sound barrier curtains would be appropriate and can provide a 10 to 15 dBA reduction in noise levels.
- **Vibration Monitoring and Measures.** WBSD shall require its contractors to conduct vibration monitoring at any residences or buildings located less than 50-feet from construction activities. Ground vibration level at the nearest residential structure to the construction site will be monitored using vibration sensor(s) or velocity transducer with adequate sensitivity capable of measuring peak particle velocity level in the frequency range of 1 Hz to 100 Hz. If the vibration level due to construction activities exceeds 0.2 inch/second, the contractor will make modifications/revisions to construction methods for approval by the City of Menlo Park.
- **Pre-Construction Notification.** Prior to construction, written notification to residents within 500 feet of the Proposed Project segment(s) undergoing construction shall be provided, identifying the type, duration, and frequency of construction activities. Notification materials shall also identify a mechanism for residents to register complaints with WBSD if construction related noise impacts should occur.

Once constructed, the influent and disposal pipelines would not produce excess noise. The WWTP would produce permanent noise, primarily from the pump station and the additional truck trips required for delivery of materials necessary for operation. The noise-generating components of the WWTP would be enclosed in buildings, which would dampen the noise. Furthermore, the treatment facility would also be located near an existing freeway, which increases the overall ambient noise levels in the area. The wastewater pump station, a noise-generating facility, will be in a location zoned as residential, but more than 100 feet from the nearest house and buried in a cul-de-sac, near the intersection of Sand Hill Road and Oak Avenue. Operation of the pump station could generate noise levels that could exceed the levels established in local noise ordinance and/or OSHA standards. Applicable noise limits in the City of Menlo Park's Municipal Code §8.06.030 for residential areas are listed in Table 3.12-1.

Table 3.12-1: General Plan Noise Limits for Residential Areas in the City of Menlo Park

Location	Exterior Noise Limits
Residential Nighttime*	50 dBA CNEL
Residential Daytime	60 dBA CNEL

*Single family residential limit at a point on the receiving property nearest where the sound source at issue generates the highest sound level.

Source: City of Menlo Park, 2015

Implementation of noise control features into design of the Proposed Project will ensure that noise-generating facilities (the WWTP and pump station) meet the City’s Municipal Code noise limits. With code compliance, operational noise impacts are considered less than significant.

- b) Construction of the Proposed Project would involve the use of heavy equipment that could create groundborne vibrations and noise. Both noise and vibration impacts are a function of the associated activity and equipment and the distance to the nearest receptor. Construction activities that could create these impacts include excavation, soil transport, pile driving, and shoring of trenches and the treatment facility site. Construction would occur in close proximity to residences, commercial uses, and a school, and these vibrations may be felt by residents living or working in proximity to the Proposed Project or could cause cosmetic or structural damage to buildings. **Mitigation Measure NOI-1** includes vibration monitoring and performance measure (0.2 inch/second) to reduce potential construction-related impacts to less than significant.

Most of the components at the treatment facility would be enclosed. Because of the nature of operations, and with compliance with the City’s noise limits during operation of proposed facilities, no excessive groundborne vibration or noise is anticipated during routine operation of the Proposed Project.

- e, f) There are no airports or airstrips within the vicinity of the Proposed Project. Thus, the Proposed Project would not expose people residing or working in the Project area to excessive noise levels.

3.13 Population and Housing

	<u>Potentially Significant Impact</u>	<u>Less Than Significant With Mitigation Incorporation</u>	<u>Less Than Significant Impact</u>	<u>No Impact</u>
Would the Project:				
a) Induce substantial population growth in an area, either directly (for example, by proposing new homes and businesses) or indirectly (for example, through extension of roads or other infrastructure)?	<input type="checkbox"/>	<input type="checkbox"/>	<input checked="" type="checkbox"/>	<input type="checkbox"/>
b) Displace substantial numbers of existing housing, necessitating the construction of replacement housing elsewhere?	<input type="checkbox"/>	<input type="checkbox"/>	<input type="checkbox"/>	<input checked="" type="checkbox"/>
c) Displace substantial numbers of people necessitating the construction of replacement housing elsewhere?	<input type="checkbox"/>	<input type="checkbox"/>	<input type="checkbox"/>	<input checked="" type="checkbox"/>

Discussion

a) As of January 2015, the population of the City of Menlo Park was 33,273 (DOF, 2015). The City’s 2010 Urban Water Management Plan (UWMP) estimates a 1% increase in population over a 30 year timespan, resulting in a 2040 population of 38,100 (City of Menlo Park, 2014). Currently, MPMWD provides water to approximately 16,000 customers, but purchases 100% of its water from the SFPUC (City of Menlo Park, 2014). In 2010, MPMWD did not use any recycled water (City of Menlo Park, 2010).

The Proposed Project is a recycled water project, and is intended to provide recycled water to meet current irrigation demands for existing customers at SHG&CC and SLAC. Provision of recycled water would not directly induce population growth because it would not produce additional water supply, but instead replace the current imported supply (purchased water) with a more desirable (locally-produced) water.

There is potential that the resulting increase of supply availability (236 AFY of potable water replaced by recycled water) from the reduced demand for purchased water could indirectly support population growth, but this growth would be within the growth framework of applicable local plans and the potential impact would be less than significant.

b, c) The Proposed Project would not displace existing housing or people; therefore it would have no displacement impacts. No impacts would occur.

3.14 Public Services

<u>Potentially Significant Impact</u>	<u>Less Than Significant With Mitigation Incorporation</u>	<u>Less Than Significant Impact</u>	<u>No Impact</u>
---------------------------------------	--	-------------------------------------	------------------

Would the Project:

- a) Would the Project result in substantial adverse physical impacts associated with the provision of new or physically altered governmental facilities, need for new or physically altered governmental facilities, the construction of which could cause significant environmental impacts, in order to maintain acceptable service ratios, response times, or other performance objectives for any of the public services:

Fire protection?	<input type="checkbox"/>	<input type="checkbox"/>	<input type="checkbox"/>	<input checked="" type="checkbox"/>
Police protection?	<input type="checkbox"/>	<input type="checkbox"/>	<input type="checkbox"/>	<input checked="" type="checkbox"/>
Schools?	<input type="checkbox"/>	<input type="checkbox"/>	<input type="checkbox"/>	<input checked="" type="checkbox"/>
Parks?	<input type="checkbox"/>	<input type="checkbox"/>	<input type="checkbox"/>	<input checked="" type="checkbox"/>
Other public facilities?	<input type="checkbox"/>	<input type="checkbox"/>	<input type="checkbox"/>	<input checked="" type="checkbox"/>

Discussion

- a) The Menlo Park Police Department and the San Mateo County Sheriff’s Department provide law enforcement services, and the California Highway Patrol provides traffic enforcement services within the Study Area. Menlo Park Fire Protection District and the San Mateo County Fire Department provide fire protection services in the Study Area.

Schools, both public and private institutions, at the elementary, middle, high school, and college levels are located in and around the Study Area, as described in *Section 3.10, Land Use and Planning*. Menlo Park Community Services owns and maintains public parks in the City. *Section 3.15, Recreation* identifies the bike paths/trails and parks located adjacent to the proposed treatment site and pipelines.

The Proposed Project would involve the production and delivery of recycled water to meet existing demand, and disposal of wastewater produced by the treatment process. The Proposed Project would not change existing demand for public services (e.g., fire and police protection, schools, parks, libraries, or health clinics) because population growth would not result from construction of the Proposed Project (see *Section 3.13, Population and Housing*). In addition, the operation and maintenance of the Proposed Project would not be labor intensive, and therefore would not substantially increase the need for new staff from any of public protection services entities (e.g., police and fire). As implementation of the Proposed Project would not change the demand for any of the public services, it would not require additional equipment or resources for those public service providers. The Proposed Project would have no impact and no mitigation is required.

3.15 Recreation

	<i>Potentially Significant Impact</i>	<i>Less Than Significant With Mitigation Incorporation</i>	<i>Less Than Significant Impact</i>	<i>No Impact</i>
Would the Project:				
a) Would the Project increase the use of existing neighborhood and regional parks or other recreational facilities such that substantial physical deterioration of the facility would occur or be accelerated?	<input type="checkbox"/>	<input type="checkbox"/>	<input type="checkbox"/>	<input checked="" type="checkbox"/>
b) Does the Project include recreational facilities or require the construction or expansion of recreational facilities which might have an adverse physical effect on the environment?	<input type="checkbox"/>	<input type="checkbox"/>	<input type="checkbox"/>	<input checked="" type="checkbox"/>

Discussion

a, b) According to Menlo Park’s Comprehensive Bicycle Development Plan, the Sand Hill Road Class II bikeway runs directly along Sand Hill Road, the same pathway of the proposed recycled water pipeline alignment path (Menlo Park, 2005). Additional recreational facilities within the vicinity of the Study Area include The Horse Park at Woodside (directly west of the Proposed Project (approximately 200 feet) across Junipero Serra-Freeway (I-280)) and the Stanford University Golf Course, which runs parallel to Sand Hill Road and the forcemain pipeline alignment.

The Proposed Project consists of a WWTP, pump station, influent pipeline, solids disposal pipeline, and recycled water distribution pipeline. It would create recycled water to offset potable water use on an existing golf course, but not cause an increase in the use of or expansion of existing parks, bikeways or other recreational facilities. Thus, no impact would occur.

3.16 Transportation/Traffic

	<i>Potentially Significant Impact</i>	<i>Less Than Significant With Mitigation Incorporation</i>	<i>Less Than Significant Impact</i>	<i>No Impact</i>
Would the Project:				
a) Conflict with an applicable plan, ordinance or policy establishing measures of effectiveness for the performance of the circulation system, taking into account all modes of transportation including mass transit and non-motorized travel and relevant components of the circulation system, including but not limited to intersections, streets, highways and freeways, pedestrian and bicycle paths and mass transit?	<input type="checkbox"/>	<input checked="" type="checkbox"/>	<input type="checkbox"/>	<input type="checkbox"/>
b) Conflict with applicable congestion management program, including, but not limited to level of				

service standards and travel demand measures, or other standards established by the county congestion management agency for designated roads or highways?	<input type="checkbox"/>	<input checked="" type="checkbox"/>	<input type="checkbox"/>	<input type="checkbox"/>
c) Result in a change in air traffic patterns, including either an increase in traffic levels or a change in location that results in substantial safety risks?	<input type="checkbox"/>	<input type="checkbox"/>	<input type="checkbox"/>	<input checked="" type="checkbox"/>
d) Substantially increase hazards due to a design feature (e.g., sharp curves or dangerous intersections) or incompatible uses (e.g., farm equipment)?	<input type="checkbox"/>	<input type="checkbox"/>	<input checked="" type="checkbox"/>	<input type="checkbox"/>
e) Result in inadequate emergency access?	<input type="checkbox"/>	<input checked="" type="checkbox"/>	<input type="checkbox"/>	<input type="checkbox"/>
f) Conflict with adopted policies, plans, or programs regarding public transit, bicycle, or pedestrian facilities, or otherwise decrease the performance or safety of such facilities?	<input type="checkbox"/>	<input checked="" type="checkbox"/>	<input type="checkbox"/>	<input type="checkbox"/>

Discussion

a, b) The Proposed Project would be constructed within roadway ROWs and within the SHG&CC property. Open trench construction would be employed for the majority of the pipeline alignment, with the possible exception of the crossing of the Hetch Hetchy Aqueduct, which may require trenchless construction (see Chapter 2, Project Description). The assumed 30-foot construction easement may require closure of some traffic lanes, thus reducing roadway capacities. In addition, construction traffic could result in increased traffic volumes. **Mitigation Measure TRA-1**, which requires development and implementation of a Traffic Control Plan, would be required to reduce traffic-related impacts of potential temporary lane closures during construction of the influent and disposal pipelines. There may be traffic impacts related to increased truck traffic during construction of the treatment facility, but no road closures are anticipated for this component of the Proposed Project. Should road closures be deemed necessary, they would be incorporated into the Traffic Control Plan for the Proposed Project.

Mitigation Measure TRA-1: Develop and Implement Traffic Control Plan

WBSD shall require its construction contractor to prepare a Traffic Control Plan which outlines all potential lane closures and detours, as necessary, in accordance with the latest edition of the "Manual of Uniform Traffic Control Devices for Construction and Maintenance Work Zones" issued by the State of California, Department of Transportation. Appropriate signage shall be utilized during construction to warn pedestrians, bicyclists and vehicles of any potential traffic hazards. One lane for through traffic shall be maintained on all roadways to allow access during construction.

Potential short-term impacts related to traffic and emergency access during construction would be mitigated to less than significant levels with implementation of this mitigation measures.

Operation of the Proposed Project would result in an estimated 128 additional truck trips to the treatment facility per year (24 for chemical deliveries and 104 for screening and grit removal). These truck trips, spread evenly over the course of the year would result in approximately 2.5 additional truck trips per week, a less than significant impact to overall traffic patterns in the area.

- c) The Proposed Project would not affect air traffic patterns, and would be located sufficiently far from an airport or airstrip to avoid creating a substantial air traffic safety risk. There would be no impact.
- d) The Proposed Project would not create or substantially increase a traffic hazard due to a design feature. The roadway ROWs excavated for pipelines may be temporary reconfigured to accommodate construction activities, but would be restored to preconstruction conditions upon project completion. Thus, impacts would be less than significant.
- e) Lane closures and other potential traffic impacts caused by construction activities associated with the Proposed Project would have potential to impede emergency response to those areas, or to areas accessed via those routes. No fire station would be directly impeded by the Proposed Project, because the nearest station is approximately 1 mile northwest of the pump station on Santa Cruz Avenue. Implementation of **Mitigation Measure TRA-1**, which requires development and implementation of a Traffic Control Plan, would reduce these impediments to less than significant levels.
- f) Upon completion, the Proposed Project would not conflict with adopted policies, plans, or programs regarding alternate transportation, nor would it decrease the safety of these facilities. There would be temporary impacts to alternative modes during project construction, such as impeded access to bus stops, bike lanes, and pedestrian walkways along the pipeline construction corridors, but these impacts would be temporary. Implementation of **Mitigation Measure TRA-1**, which requires development and implementation of a Traffic Control Plan, would reduce potential impacts to less than significant.

3.17 Utilities and Service Systems

	<u>Potentially Significant Impact</u>	<u>Less Than Significant With Mitigation Incorporation</u>	<u>Less Than Significant Impact</u>	<u>No Impact</u>
Would the Project:				
a) Exceed wastewater treatment requirements of the applicable Regional Water Quality Control Board?	<input type="checkbox"/>	<input type="checkbox"/>	<input checked="" type="checkbox"/>	<input type="checkbox"/>
b) Require or result in the construction of new water or wastewater treatment facilities or expansion of existing facilities, the construction of which could cause significant environmental effects?	<input type="checkbox"/>	<input type="checkbox"/>	<input checked="" type="checkbox"/>	<input type="checkbox"/>
c) Require or result in the construction of new storm water drainage facilities or expansion of existing facilities, the construction of which could cause significant environmental effects?	<input type="checkbox"/>	<input type="checkbox"/>	<input checked="" type="checkbox"/>	<input type="checkbox"/>
d) Have sufficient water supplies available to serve the Project from existing entitlements and resources, or are new or expanded entitlements needed?	<input type="checkbox"/>	<input type="checkbox"/>	<input type="checkbox"/>	<input checked="" type="checkbox"/>

- | | | | | |
|---|--------------------------|--------------------------|-------------------------------------|-------------------------------------|
| e) Result in a determination by the wastewater treatment provider which serves or may serve the Project that it has adequate capacity to serve the Project’s projected demand in addition to the provider’s existing commitments? | <input type="checkbox"/> | <input type="checkbox"/> | <input type="checkbox"/> | <input checked="" type="checkbox"/> |
| f) Be served by a landfill with sufficient permitted capacity to accommodate the Project’s solid waste disposal needs? | <input type="checkbox"/> | <input type="checkbox"/> | <input checked="" type="checkbox"/> | <input type="checkbox"/> |
| g) Comply with federal, state, and local statutes and regulations related to solid waste? | <input type="checkbox"/> | <input type="checkbox"/> | <input type="checkbox"/> | <input checked="" type="checkbox"/> |

Discussion

- a) WBSD provides wastewater collection and conveyance services for unincorporated San Mateo and Santa Clara counties, as well as the City of Menlo Park. WBSD conveys raw wastewater, through the Menlo Park Pump Station and force main, to the SVCW treatment facility in Redwood City for treatment and discharge to deep-water outfalls in the San Francisco Bay (see **Appendix A** for more detail). Discharge of solids to SVCW from the Proposed Project would be in compliance with the SVCW NPDES permit, as discussed in *Section 2.9 Hydrology and Water Quality*, above. The Proposed Project would not cause SVCW to exceed the wastewater treatment requirements of the RWQCB and therefore results in less than significant impacts.
- b) The Proposed Project proposes the construction of a WWTP, influent and disposal pipelines, and recycled water delivery pipelines to serve new recycled water customers. Implementation of the Proposed Project does not require new facilities or expansion of existing facilities beyond those evaluated in this MND. Thus, impacts are considered less than significant.
- c) The Proposed Project would require additional on-site drainage facilities at the WWTP site. The Proposed Project would increase the amount of impervious surface at the site, increasing total stormwater runoff that would need to be captured and discharged. Given that the current site is partially on a hillside that drains to the golf course, any increase in stormwater runoff associated with the WWTP would be relatively low and would be captured onsite. An onsite stormwater collection system will be constructed in compliance with the San Francisco Bay MS4 Permit and WBSD’s standard construction practices. Under the MS4 provisions, all projects are responsible for implementing low impact development (LID) techniques to address stormwater runoff through source control, site design, and stormwater treatment measures. Thus, impacts are expected to be less than significant.
- d) The Proposed Project would augment the District’s capacity to serve the region’s water demands. Thus, no adverse impacts would occur.
- e) The Proposed Project would not increase the concentration of wastewater produced in the Study Area, but decrease the quantity of wastewater produced. It would convey waste produced at the WWTP to the WBSD system for disposal. Based on the project size and relative contribution to the collection system, the current SVCW NPDES permit is adequate to accommodate the additional flow. Thus, impacts are expected to be less than significant.
- f, g) The main contributor to solid waste generated by the Proposed Project would be the excavation and disposal of soil from the WWTP site. Solid waste (soil) generated by the Proposed Project would likely be hauled to Ox Mountain Sanitary Landfill, which can accept up to 3,598 tons per day. It has a capacity of 37.9 million cubic yards, with an expected closure date of 2018 (CalRecycle, 2015). In 2011, the Ox Mountain Landfill received a total of 700,600 tons,

averaging 2,260 tons per day (CalRecycle, 2015). Approximately 11,000 CY of excavated materials would be off hauled from the WWTP and pump station project site. Assuming a truck capacity of 20 CY, off haul of excavated materials would require approximately 550 truck trips. This projected rate of disposal would not exceed the permitted daily acceptance levels at Ox Mountain Sanitary Landfill, at only about 0.028% of the daily maximum. The landfill would have sufficient permitted capacity to accommodate the Proposed Project’s solid waste disposal needs. Identifying an alternate disposal site and/or construction timing should the identified landfill not be able to accommodate all of the waste, would further reduce any potential impacts. Solid waste would be disposed of in accordance with all applicable federal, state, and local statutes and regulations. Once constructed, operation and maintenance activities would generate minimal solid waste. For this reason, implementation of the Proposed Project would not exceed permitted capacity at local landfills. The impact would be less than significant and no mitigation is required.

3.18 Mandatory Findings of Significance

	<u>Potentially Significant Impact</u>	<u>Less Than Significant With Mitigation Incorporation</u>	<u>Less Than Significant Impact</u>	<u>No Impact</u>
a) Does the Project have the potential to degrade the quality of the environment, substantially reduce the habitat of a fish or wildlife species, cause a fish or wildlife population to drop below self-sustaining levels, threaten to eliminate a plant or animal community, reduce the number or restrict the range of a rare or endangered plant or animal or eliminate important examples of the major periods of California history or prehistory?	<input type="checkbox"/>	<input checked="" type="checkbox"/>	<input type="checkbox"/>	<input type="checkbox"/>
b) Does the Project have impacts that are individually limited, but cumulative considerable? (“Cumulative considerable” means that the incremental effects of a project are considerable when viewed in connection with the effects of past projects, the effects of other current projects, and the effects of probable future projects)?	<input type="checkbox"/>	<input checked="" type="checkbox"/>	<input type="checkbox"/>	<input type="checkbox"/>
c) Does the Project have environmental effects which will cause substantial adverse effects on human beings, either directly or indirectly?	<input type="checkbox"/>	<input checked="" type="checkbox"/>	<input type="checkbox"/>	<input type="checkbox"/>

Discussion

- a) The potential biological impacts of the Proposed Project are discussed in *Section 3.4 Biological Resources*, above. The potential impacts to cultural resources from the Proposed Project are addressed in *Section 3.5 Cultural Resources*, above. Mitigation measures are included herein to reduce potential biological and cultural impacts to less than significant levels.
- b) Most of the potential impacts from the Proposed Project would occur during construction. While all potential impacts of the Proposed Project could be mitigated to less than significant, there is potential for cumulatively considerable impacts in combination with other past, present, and

probable future projects. This is most likely to occur in relation to air quality emissions relative to the BAAQMD exceedance of PM₁₀, PM_{2.5} and ozone standards. However, implementation of the mitigation measure described in *Section 3.3 Air Quality* would reduce the Proposed Project's contribution to cumulative air quality impacts to less than significant.

- c) If mitigation measures identified herein were not implemented, the Proposed Project would have environmental effects that could cause substantial adverse effects on humans. The potential impacts with the greatest potential adverse effects on humans and human health include air quality, biological resources, cultural resources, hazardous materials, noise, and traffic. Mitigation measures are available and incorporated herein to address potential environmental impacts to less than significant levels.

This page intentionally left blank

Chapter 4 Federal Cross-cutting Environmental Regulations Evaluation

This section describes the status of compliance with relevant federal laws, executive orders, and policies, and the consultation that has occurred to date or will occur in the near future. The topics are based in part on the SWRCB’s Clean Water State Revolving Fund Program Federal Cross-cutting Environmental Regulations Evaluation Form for Environmental Review and Federal Coordination.

4.1 Federal Endangered Species Act

Section 7 of the Federal Endangered Species Act (FESA) requires federal agencies, in consultation with the Secretary of the Interior, to ensure that their actions do not jeopardize the continued existence of endangered or threatened species, or result in the destruction or adverse modification of the critical habitat of these species. Under Section 7, a project that could result in incidental take of a listed threatened or endangered species must consult with the USFWS to obtain a Biological Opinion (BO). If the BO finds that the project could jeopardize the existence of a listed species (“jeopardy opinion”), the agency cannot authorize the project until it is modified to obtain a “nonjeopardy” opinion. *Section 3.4 Biological Resources* describes the four sensitive species that were observed in the area, two of which are federally listed: California Red Legged Frog (federally threatened), San Francisco Garter Snake (federal endangered), California Tiger Salamander (3 populations federally listed, but none in the Study Area), and Western Pond Turtle (under federal status review). No impacts are anticipated to occur for any of these sensitive wildlife species because there is limited habitat available within the potential area of impact. Where there is a potential for sensitive species to occur within the Study Area, Mitigation Measure BIO-1 would reduce potential impacts to less than significant. Thus, the Proposed Project would not contribute to cumulatively considerable impacts and the lead agency would be in compliance with this Act.

4.2 National Historic Preservation Act (NHPA), Section 106

The purpose of this Act is to protect, preserve, rehabilitate, or restore significant historical, archeological, and cultural resources. Section 106 requires Federal agencies to take into account effects on historic properties. Section 106 review involves a step-by-step procedure described in detail in the implementing regulations (36 CFR Part 800). As described in *Section 3.5 Cultural Resources*, a cultural resource assessment for the Proposed Project was conducted and is attached to this MND as **Appendix D**. The analysis includes a Section 106 evaluation for the Proposed Project and can be submitted the consultation process with the State Historic Preservation Officer (SHPO). Concurrence by SHPO would ensure compliance with the NHPA.

No cultural resources were identified within the project site during this study. Therefore, no impacts to historical resources under CEQA and no effects to historic properties under the NHPA for the Proposed Project are expected. However, based on the high level of prehistoric sites located adjacent to and surrounding the project APE, the APE is sensitive for buried archaeological resources. Based on this sensitivity, archaeological and Native American monitoring for all ground-disturbance activities, as described in **Mitigation Measure CUL-1** and **CUL-2**, would be implemented to mitigate any potential impacts to less than significant.

4.3 Clean Air Act

U.S. Congress adopted general conformity requirements as part of the Clean Air Act (CAA) Amendments in 1990 and the USEPA implemented those requirements in 1993 (Sec. 176 of the CAA (42 U.S.C. § 7506) and 40 CFR Part 93, Subpart B). General conformity requires that all federal actions “conform” with the State Implementation Plan as approved or promulgated by USEPA. The purpose of the general

conformity program is to ensure that actions taken by the federal government do not undermine state or local efforts to achieve and maintain the national ambient air quality standards. Before a federal action is taken, it must be evaluated for conformity with the State Implementation Plan. All “reasonably foreseeable” emissions predicted to result from the action are taken into consideration. These include direct and indirect emissions, and must be identified as to location and quantity. If it is found that the action would create emissions above de minimis threshold levels specified in USEPA regulations (40 CFR § 93.153(b)), or if the activity is considered “regionally significant” because its emissions exceed 10 percent of an area’s total emissions, the action cannot proceed unless mitigation measures are specified that would bring the proposed Project into conformance. As described in *Section 3.3 Air Quality*, the Study Area lies within the San Francisco Bay Area Air Basin. The results of the air quality modeling showed that pollutant emissions would not exceed Federal General Conformity significance thresholds. Accordingly, the lead agency would be in compliance with this Act.

4.4 Coastal Zone Management Act

The Coastal Zone Management Act (CZMA), passed by Congress in 1972 and managed by the National Oceanic and Atmospheric Administration’s (NOAA) Office of Ocean and Coastal Resource Management, is designed to balance completing land and water issues in coastal zones. It also aims to “preserve, protect, develop, and where possible, to restore or enhance the resources of the nation’s coastal zone.” Within California, the CZMA is administered by the Bay Conservation and Development Commission, the California Coastal Conservancy, and the California Coastal Commission. No portion of the Proposed Project is within the coastal zone, as the Study Area is located approximately 4.5 miles from the coast. Therefore, the Coastal Zone Management Act does not apply to the Proposed Project.

4.5 Farmland Protection Policy Act

The Farmland Protection Policy Act (FPPA) requires a federal agency to consider the effects of its actions and programs on the nation’s farmlands. The FPPA is intended to minimize the impact of federal programs with respect to the conversion of farmland to nonagricultural uses. It assures that, to the extent possible, federal programs are administered to be compatible with state, local, and private programs and policies to protect farmland. As described in *Section 3.2 Agriculture and Forestry Resources*, the Proposed Project would be located entirely within Urban/Built and Other land designations and would not occur within any designated important farmlands. As such, the lead agency would be in compliance with this Act.

4.6 Executive Order (EO) 11988 – Floodplain Management

EO 11988 requires federal agencies to recognize the values of floodplains and to consider the public benefits from restoring and preserving floodplains. As described in *Section 3.9 Hydrology and Water Quality*, none of the Proposed Project facilities lie within the 100- year floodplain as designated by the FEMA. As such, the lead agency would be in compliance with this EO.

4.7 Federal Migratory Bird Treaty Act, Bald and Golden Eagle Protection Act, and Executive Order 13168

The Migratory Bird Treaty Act and the Bald and Golden Eagle Protection Act prohibit the take of migratory birds (or any part, nest, or eggs of any such bird) and the take and commerce of eagles. EO 13168 requires that any project with federal involvement address impacts of federal actions of migratory birds. As described in *Section 3.4 Biological Resources*, the Proposed Project would have less than significant impact on nesting birds with implementation of **Mitigation Measure BIO-2** if construction cannot be avoided during nesting season. Thus, the lead agency would be in compliance with this EO.

4.8 Executive Order 11990 – Protection of Wetlands

Under EO 11990, federal agencies must avoid affecting wetlands unless it determines that no practicable alternative is available. As described in *Section 3.4 Biological Resources*, the Study Area does not support federally protected wetlands as defined by CWA Section 404 and therefore no impacts are anticipated. A concrete drainage in the valley oak stand adjacent to, but outside of, the WWTP footprint is potentially considered a jurisdictional feature. It does not support any hydrophytic vegetation and the adjacent banks support upland vegetation. This channel collects runoff from Interstate 280 and directs it northwest outside the Study Area. This drainage channel could be considered a non-wetland water of the United States if it drains to a jurisdictional water. However, because it is located outside of the Study Area, impacts are considered less than significant. Thus, the lead agency would be in compliance with EO 11990.

4.9 Wild and Scenic Rivers Act

The Wild and Scenic Rivers Act was passed in 1968 to preserve and protect designated rivers for their natural, cultural, and recreational value. There are no designated Wild and Scenic Rivers within the Study Area, nor will any designated rivers be adversely affected by the Proposed Project. As a result, the Wild and Scenic Rivers Act does not apply to the Proposed Project.

4.10 Safe Drinking Water Act – Source Water Protection

Section 1424(e) of the Safe Drinking Water Act established the USEPA's Sole Source Aquifer Program. This program protects communities from groundwater contamination from federally-funded projects. Within USEPA's Region 9, which includes California, there are nine sole source aquifers. None of these sole source aquifers are located within the Study Area. Therefore, the Sole Source Aquifer Program does not apply to the Proposed Project, and the lead agency would be in compliance with Section 1424(e) of the Safe Drinking Water Act.

4.11 Executive Order on Trails for America in the 21st Century

The EO on Trails for America requires federal agencies to protect, connect, promote, and assist trails of all types throughout the United States. The Proposed Project would not result in any impacts on trails. Thus, no adverse effects on trails would occur and the lead agency would be in compliance with this EO.

4.12 Executive Order 13007 – Indian Sacred Sites

Sacred sites are defined in Executive Order 13007 (May 24, 1996) as "any specific, discrete, narrowly delineated location on Federal land that is identified by an Indian tribe, or Indian individual determined to be an appropriately authoritative representative of an Indian religion, as sacred by virtue of its established religious significance to, or ceremonial use by, an Indian religion; provided that the tribe or appropriately authoritative representative of an Indian religion has informed the agency of the existence of such a site." The Proposed Project would not be located on or impact any Federal lands and therefore would not affect any Indian sacred sites under this EO.

4.13 Magnuson-Stevens Fishery Conservation and Management Act

The Magnuson-Stevens Fishery Conservation and Management Act (Magnuson-Stevens Act) of 1976 as amended (16 U.S.C. § 1801 et seq.), is the primary act governing federal management of fisheries in federal waters, from the 3-nautical-mile state territorial sea limit to the outer limit of the U.S. Exclusive Economic Zone. It establishes exclusive U.S. management authority over all fishing within the Exclusive Economic Zone, all anadromous fish throughout their migratory range except when in a foreign nation's waters, and all fish on the continental shelf. The Act also requires federal agencies to consult with NMFS on actions that could damage Essential Fish Habitat (EFH), as defined in the 1996 Sustainable Fisheries

Act (Public Law 104-297). EFH includes those habitats that support the different life stages of each managed species. A single species may use many different habitats throughout its life to support breeding, spawning, nursery, feeding, and protection functions. EFH can consist of both the water column and the underlying surface (e.g., streambed) of a particular area. The Study Area is on the boarder of the San Francisco Bay HUC designated EFH for Chinook salmon and Coho salmon. As described in *Section 3.4, Biological Resources*, the project is not expected to have adverse effect on resident or migratory fish, wildlife species, or fish habitat in the Study Area.

4.14 Environmental Justice

This section describes the existing socioeconomic resources in the Study Area and the regulatory setting pertaining to environmental justice-related issues. This section also evaluates the potential for the Proposed Project to disproportionately affect minority or low-income groups.

The USEPA defines environmental justice as: “The fair treatment and meaningful involvement of all people regardless of race, color, national origin, or income with respect to the development, implementation, and enforcement of environmental laws, regulations, and policies. Fair treatment means no group of people, including racial, ethnic, or economic groups should bear a disproportionate share of the negative environmental consequences resulting from industrial, municipal, and commercial operations or the execution of Federal, state, local, and tribal programs and policies.”

Economic conditions in the Study Area are generally better than national averages. The median household income of Menlo Park, CA from 2009-2013 was \$112,262 (US Census Bureau, 2015). The unemployment rate of Menlo Park, CA is one of the lowest in the California at 2.6% (County of San Mateo, 2015).

Minority and Low Income Communities

According to CEQA and USEPA guidelines, a minority population is present in a Study Area if the minority population of the affected area exceeds 50 percent, or if the minority population percentage of the affected area is meaningfully greater than the minority population percentage in the general population or other appropriate unit of geographic analysis. USEPA guidelines recommend that analysis of low-income communities consider U.S. Census Bureau’s poverty level definitions, as well as applicable state and regional definitions of low-income and poverty communities. U.S. Census data define the poverty level based on income, household size, and number of minors. Poverty levels range from \$11,888 (one person household) to \$51,844 (nine or more person household with one related minor). California’s Department of Water Resources (DWR) defines disadvantaged communities (DACs) as those with a median household income (MHI) that is 80 percent or less than the statewide MHI. Based on data from the American Community Survey (ACS), statewide 2013 MHI was \$61,094, and low income communities (DACs) were those with an MHI of \$48,875. DWR’s definition was used to define low income communities for this analysis.

Minority Communities

A review of demographic and economic data for the Study Area produced as part of the 2010 Census and also presented in the USEPA’s Environmental Justice Screening and Mapping Tool (EJSCREEN) indicates the Study Area does not include minority communities (U.S. Census Bureau, 2010). Table 4.13-1 below summarizes minority population data for the Study Area.

Table 4.13-1: EJSCREEN Census 2010 Summary Report Information

Summary	Census 2010
Population	5,629
Minority Population	1,417
% Minority	25%

Low Income Communities

None of the Proposed Project alignments fall within low income communities. The northeastern extent of the Proposed Project is near a Census Block Group DAC, but this area is outside of the Study Area and primarily consists of Stanford University and is likely categorized as a DAC due to discrepancies in Census data at this location. None of the customers served by the proposed Project are located within a low income community, and no aboveground facilities fall within low income areas (see Figure 4.13-1).

Figure 4.13-1: Low Income Communities in Study Area

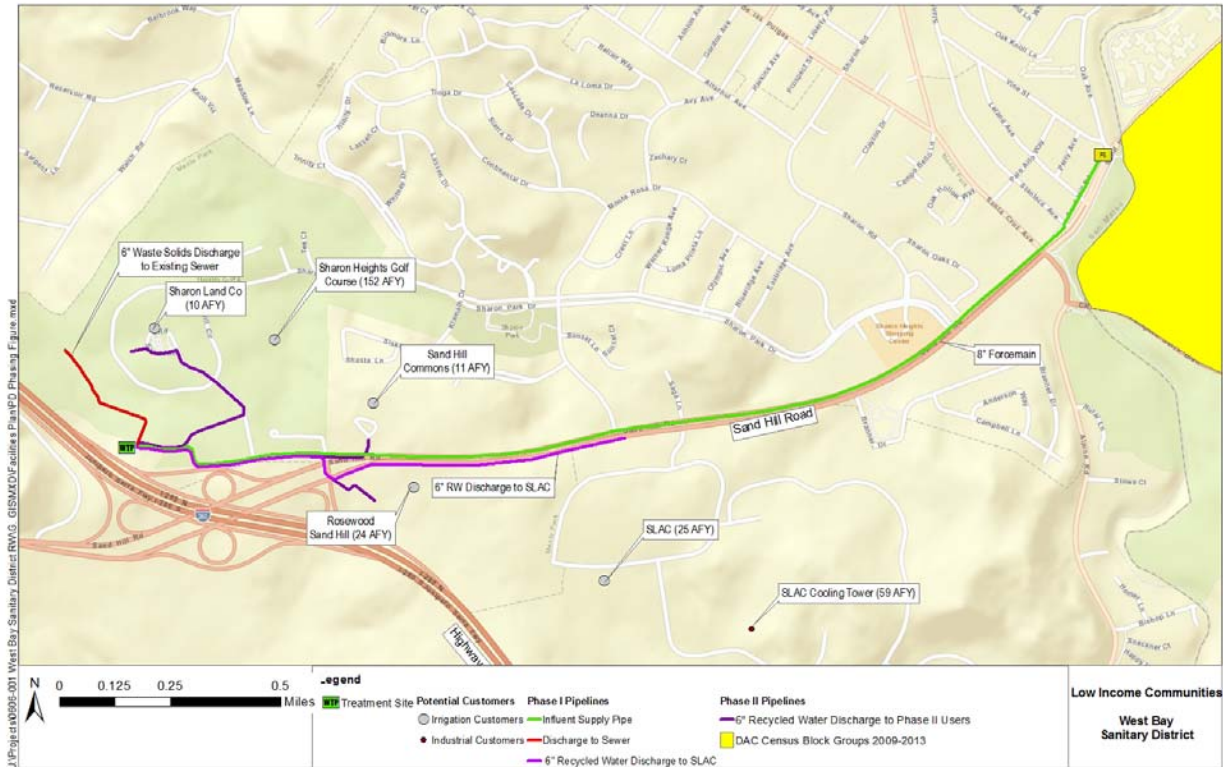

For the purposes of this analysis, an impact related to environmental justice would be significant if the Proposed Project would cause impacts to minority or low-income populations that are disproportionately high and adverse, either directly, indirectly, or cumulatively. The Proposed Project would not result in any impacts on minority or low income communities. Thus, no adverse environmental justice impacts would occur.

This page intentionally left blank

Chapter 5 Report Preparation

5.1 Report Authors

This report was prepared by WBSD, RMC Water and Environment (RMC), and Rincon Consulting, Inc. Staff from these agencies and companies that were involved include the following:

West Bay Sanitary District

- Phil Scott
- Bill Kitajima

RMC Water and Environment

- Rosalyn Prickett, AICP
- Christy Kennedy, P.E.
- Marc Nakamoto, P.E.
- Josh Uecker
- Shelly Masuda
- Lauren Salberg
- Simon Kobayashi

Rincon Consulting, Inc.

- Kyle Brudvik
- David Daitch, Ph.D.
- Duane Vander Pluym, D.Env.
- Michele Lee
- Colby J. Boggs
- Craig Huff
- Katherine Warner
- Breana Campbell
- Hannah Haas

5.2 References

Association of Bay Area Governments (ABAG). 2013. Shaking Hazard Map. Accessed March 31, 2015.

Available: <http://resilience.abag.ca.gov/earthquakes/>

Association of Bay Area Governments (ABAG). 2014. ABAG GIS Hazard WebViewer. Accessed August 27, 2015. Available:

<http://gis.abag.ca.gov/website/Hazards/?hlyr=northSanAndreas&co=6081#nogo1>.

Association of Bay Area Governments (ABAG). 2015. Priority Conservation Areas Map. Accessed September 1, 2015. Available:

http://abag.ca.gov/priority/conservation/images/PCA_Map_Updated.jpg

- Bay Area Air Quality Management District (BAAQMD). 2010. California Environmental Quality Act Air Quality Guidelines. Accessed August 27, 2015. Available: http://www.baaqmd.gov/~media/files/planning-and-research/ceqa/draft_baaqmd_ceqa_guidelines_may_2010_final.pdf?la=en
- California Department of Conservation. 2015. California Important Farmland Finder. Accessed March 26, 2015. Available: <http://maps.conservation.ca.gov/ciff/ciff.html>
- California Department of Finance (DOF). 2015. Tables of January 2015 City Population Ranked by Size, Numeric, and Percent Changes. Accessed September 18, 2015. Available: <http://www.dof.ca.gov/research/demographic/reports/estimates/e-1/view.php>.
- California Department of Resources Recycling and Recovery (CalRecycle). 2015. Facility/Site Summary Details: Corinda Los Trancos Landfill (Ox Mountain) (41-AA-0002). Accessed August 26, 2015. Available: <http://www.calrecycle.ca.gov/SWFacilities/Directory/41-AA-0002/Detail/>
- California Department of Transportation (Caltrans). No Date (N.D.). California Scenic Highway Mapping System – San Mateo County. Accessed March 26, 2015. Available: http://www.dot.ca.gov/hq/LandArch/scenic_highways/
- California Natural Diversity Database (CNDDDB). 2015. RareFind 3. Accessed September 18, 2015. Available: <http://www.dfg.ca.gov/biogeodata/cnddb/mapsanddata.asp>
- California Environmental Protection Agency Air Resources Board (CARB). 2010. Revisions to the Regulation for Mandatory Reporting of Greenhouse Gas Emissions Pursuant to the California Global Warming Solutions Act of 2006 (Assembly Bill 32). Accessed August 27, 2015. Available: <http://www.arb.ca.gov/regact/2010/ghg2010/ghgisor.pdf>
- California Geologic Survey (CGS). 2010. 2010 Fault Activity Map of California. Accessed August 31, 2015. Available: <http://www.quake.ca.gov/gmaps/FAM/faultactivitymap.html#>
- California Geologic Survey. 2015. Regulatory Maps. Accessed March 30, 2015. Available: <http://www.quake.ca.gov/gmaps/WH/regulatorymaps.htm>
- California Geologic Survey. 2015a. Minerals. Accessed September 18, 2015. Available: <http://www.conservation.ca.gov/cgs/minerals>.
- California State Water Resources Control Board (CWSRCB). 2015. Geotracker Database. Accessed September 3, 2015. Available: <http://geotracker.waterboards.ca.gov/map/?CMD=runreport&myaddress=2900+Sand+Hill+Road%2C+Menlo+Park%2C+CA%2C+94025>
- City of Menlo Park. 2005. Comprehensive Bicycle Development Plan. Accessed September 3, 2015. Available: <http://www.menlopark.org/DocumentCenter/Home/View/372>.
- City of Menlo Park. 2009. Climate Change Action Plan. Accessed August 27, 2015. Available: <http://www.menlopark.org/DocumentCenter/View/1346>.
- City of Menlo Park. 2010. City of Menlo Park Emergency Operation Plan. Accessed August 31, 2015. Available: <http://www.menlopark.org/DocumentCenter/View/815>
- City of Menlo Park. 2013. Housing Element Update, General Plan Consistency Update, and Zoning Ordinance Amendments Environmental Assessment. Accessed March 23, 2015. Available: <http://menlopark.org/DocumentCenter/View/4795>
- City of Menlo Park. 2015. Community Character Report, Public Review Draft. Accessed March 23, 2015. Available: <http://menlopark.org/DocumentCenter/View/6298>

- City of Menlo Park. 2015. Menlo Park Municipal Code. Accessed April 7, 2015. Available: <http://www.codepublishing.com/ca/menlopark/>
- Kroeber, Alfred J. 1925. *Handbook of the Indians of California*. Bureau of American Ethnology, Bulletin 78. Originally published 1925, Smithsonian Printing Office, Washington, D.C. Unabridged reprint 1976, Dover Publications, Inc. New York.
- County of San Mateo. 2015. Unemployment by City SMC. San Mateo Open Data Portal. Accessed October 13, 2015. Available: <https://data.smcgov.org/Business/Unemployment-by-city-SMC/33n3-pmpt>
- Milliken, R. T., R. T. Fitzgerald, M. G. Hylkema, R. Groza, T. Origer, D. G. Bieling, A. Leventhal, R. S. Wiberg, A. Gottsfield, D. Gillette, V. Bellifemine, E. Strother, R. Cartier, and D. A. Fredrickson. 2007. Punctuated Cultural Change in the San Francisco Bay Area. In *California Prehistory: Colonization, Culture, and Complexity*, edited by Terry L. Jones and Kathryn A. Klar, pp.99-124. AltaMira Press.
- Moratto, Michael. 1984. *California Archaeology*. Academic Press, New York.
- National Resources Conservation Service (NRCS). 2015. Web Soil Survey Interactive Map. Accessed August 27, 2015. Available: <http://websoilsurvey.sc.egov.usda.gov/App/WebSoilSurvey.aspx>.
- San Mateo County Energy Efficiency Climate Action Plan. 2013. Draft Environmental Impact Report SCH#2012052039. Accessed August 27, 2015. Available <http://planning.smcgov.org/sites/planning.smcgov.org/files/documents/files/San%20Mateo%20County%20EECAP%20Draft%20EIR.pdf>
- San Mateo County. 1986. General Plan: Mineral Resources. Accessed September 18, 2015. Available: <https://planning.smcgov.org/sites/planning.smcgov.org/files/SMC-GP%201986.pdf>.
- United States Census Bureau. 2014. State and County QuickFacts. Accessed October 13, 2015. Available: <http://quickfacts.census.gov/qfd/states/06/0646870.html>
- United States Department of Agriculture. 2015. Web Soil Survey, Soil Map. Accessed April 7, 2015. Available: <http://websoilsurvey.sc.egov.usda.gov/App/WebSoilSurvey.aspx>
- United States Fish and Wildlife Service (USFWS). 2015. National Wetlands Inventory: Wetlands Mapper. Accessed September 18, 2015. Available: <http://www.fws.gov/wetlands/Data/Mapper.html>.
- United States Fish and Wildlife Service (USFWS). 2015a. FWS Critical Habitat for Threatened & Endangered Species. Accessed September 18, 2015. Accessed: <http://ecos.fws.gov/crithab/flex/crithabMapper.jsp?>
- United States Geological Survey. 2006. Susceptibility Map of the San Francisco Bay Area. Accessed March 31, 2015. Available: <http://geomaps.wr.usgs.gov/sfgeo/liquefaction/susceptibility.html>
- United States Geological Survey. 2013. Bay Area Faults Layer. Accessed August 27, 2015. Available: <http://earthquake.usgs.gov/regional/nca/virtualtour/bayarea.php>
- United States Geological Survey. 2013. Shaking Hazard Map of the San Francisco Bay Area. Accessed March 31, 2015. Available: <http://resilience.abag.ca.gov/earthquakes/>
- West Bay Sanitary District. 2014. West Bay Sanitary District Recycled Water Market Assessment. Prepared by RMC Water and Environment.